



B&H SURGICAL

Specializing in OB/GYN and GI Products

The World's Source for Quality OB/GYN Products

- German Stainless Steel Instruments
- HSG Catheters & Trays
- LLETZ LOOP Electrodes
- Uterine Manipulators/Injectors
- Endometrial Suction Curettes



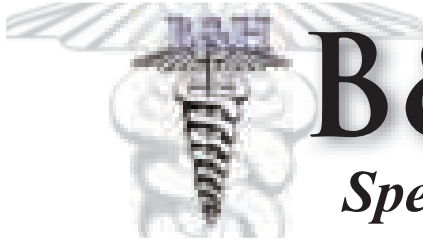

B&H SURGICAL

Specializing in OB/GYN and GI Products

In 1998 **B & H Surgical** began its journey in Southern California by *specializing in OB/GYN and GI products.*

Today we are a nationally recognized company offering our customers a comprehensive product line that includes office gynecology, GYN surgery, GI endoscopy, plastic surgery, and radiology products. Within our specialty we strive to beat our competition in quality, price, and service.

Our extensive product line brings us into the OB/GYN practice with colposcopy, electrosurgery, and fertility supplies and then takes us into the hospital operating room with GYN surgery, laparoscopic and GI endoscopy instruments as well as the radiology department with women's imaging products.

At B & H Surgical our goal is to serve our customers with the utmost customer service and sales representation. We strive to provide our customers with the exact products required to meet their needs.

We hope that you will give us the opportunity to take care of your needs and implement this OB/GYN catalog.

B&H SURGICAL

P.O. Box 800192

Santa Clarita, CA 91380-0192

Toll-Free: (800) 971-9066 or (661) 257-0788

Fax: (661) 257-0688

www.bhsurgical.com

E-mail: sales@bhsurgical.com

Table of Contents

OB/GYN CATHETERS/DISPOSABLES

SECTION I

Uterine Manipulator/Injector	1
HS/ HSG/SIS Catheters	2
Stylet for Catheters	2
HSG Tray	2
eZinject Sonohysterography Catheter	3
Sono-Inject Catheter	3
Uterine Injectors	4
Disposable Os Finders	5
Disposable Uterine Sounds	5
Endometrial Suction Curettes	5

OB/GYN INSTRUMENTS/PRODUCTS

SECTION II

Biopsy Forceps	6-8
Endocervical/Endometrial Curettes	9
Endocervical Specula	10
Vaginal Specula	11-13
Weighted Specula	14-15
Vaginal Retractors	16-17
Uterine Dilators	18-20
Uterine Sounds	21
IUD Hooks	21
OB/GYN Hooks	22
Uterine Curettes	23
Tenaculum Forceps	24-25
Vulsellum Forceps	25-28
Ovum Forceps	26-28
Hysterectomy Forceps	29-31
Vaginal Dilators, Silicone	32
Pessaries	32-37
Cannulae	38
Ligature Carriers	38
Intestinal Instrumentation	39
Circumcision Clamps	39
Corson Myoma Grasping Forceps	40
Misc. OB/GYN Instruments	40

LLETZ/LEEP

SECTION III

Loop Electrodes	41
Electrode Pads	42
LEEP tubing & filters	42
Misc. LEEP accessories	42
Nonconductive Instruments	43-44

SCISSORS

SECTION IV

ZED Scissors	45
OB/GYN Scissors	45-46
Operating Scissors	47-48
Metzenbaum Scissors	49
Bandage Scissors	50
Small Scissors	50

OTHER FORCEPS

SECTION V

Dressing Forceps	51
Tissue Forceps	51
Adson Forceps	52
Hemostatic Forceps	53-55
Sponge Forceps	56
Misc Forceps	56-58

NEEDLE HOLDERS

SECTION VI

Needle Holders	59-65
----------------	-------

OTHER RETRACTORS

SECTION VII

Self Retaining Retractors	66-67
Deaver Retractors	68
Ribbon Retractors	68
Misc. Retractors	69-71

MISCELLANEOUS INSTRUMENTS

SECTION VIII

Towel Clamps	72
Dermal Punches	72
Scalpel Handles	72



TMI1151 Zinnanti Uterine Manipulator/Injector

- Pear shaped balloon for optimal hold which is a better seal at the internal os
- Reduced catheter shaft (4.5mm) allows for easy insertion
- Flexible extension prevents cracking of luer fitting

LATEX FREE



TMI1171 EZ Glide Manipulator

- New sliding handle adjusts after insertion and then locks into place to maintain a secure trauma free hold on the uterus
- Handle has larger grip for better leverage during manipulation
- Pear shaped balloon provides optimal hold which forms a better seal at the internal os
- Flexible extension prevents cracking of luer fitting
- Longer shaft to better accommodate Plus-Size patients
- Central lumen provides for easy injection
- Atraumatic beveled catheter tip protects uterine wall

LATEX FREE

Ideal for:

- Laparoscopic Tubal Occlusion
- Minilaparotomy
- Fertility Exams
- Laparoscopic Assisted Vaginal Hysterectomy (LAVH)
- Diagnostic and Operative Laparoscopy
- Salpingoplasty
- Laparoscopic Supracervical Hysterectomy (LSH)

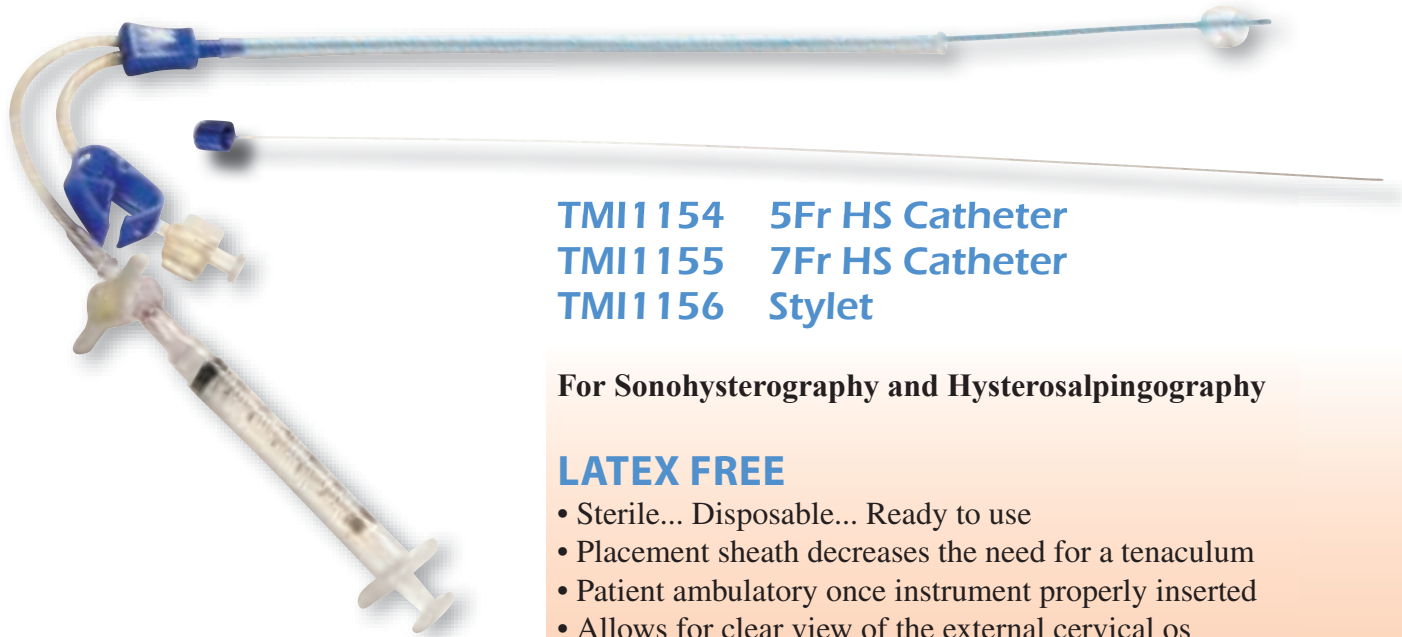

TMI1154 5Fr HS Catheter
TMI1155 7Fr HS Catheter
TMI1156 Stylet

For Sonohysterography and Hysterosalpingography

LATEX FREE

- Sterile... Disposable... Ready to use
- Placement sheath decreases the need for a tenaculum
- Patient ambulatory once instrument properly inserted
- Allows for clear view of the external cervical os
- Stylet available for cases when additional stiffness is needed



TMI1157 HSG Tray

Sterile and ready to use

LATEX FREE

- 1 ea. Wrap CSR 30"
- 5 ea. Gauze 3"x3" 12 ply
- 1 ea. Medium Speculum, Welch Allyn
- 1 ea. Needle, 18G x 1 1/2"
- 2 ea. Swabsticks, OB/GYN 8"
- 1 ea. PVP Ointment, 1 gm
- 2 ea. PVP Solution, 1 oz
- 1 ea. Flexible Cervical Dilator
- 1 ea. Uterine Sound
- 1 ea. Syringe, 20CC
- 1 ea. Lubricating Jelly
- 1 ea. Drape with 2 1/2" Fenestration
- 2 ea. Sponge Prep Sticks 6"
- 1 ea. OB Pad
- 1 ea. Tray 9"x10"x2"
- 1 ea. Tray 5"x4"x1"
- 1 ea. Extension Tubing Set 36" M/F



TMI1162 eZinject Catheter

- Sterile and ready to use
- Simple to use - insert and inject
- No distal balloon to block your view of the uterus
- Specially designed tip helps prevent leakage



TMI1170 Sono-Inject

- Sterile and ready to use
- 5Fr size for easy insertion
- Placement sheath decreases the need for a tenaculum
- No balloon for a clear view of the external cervical os

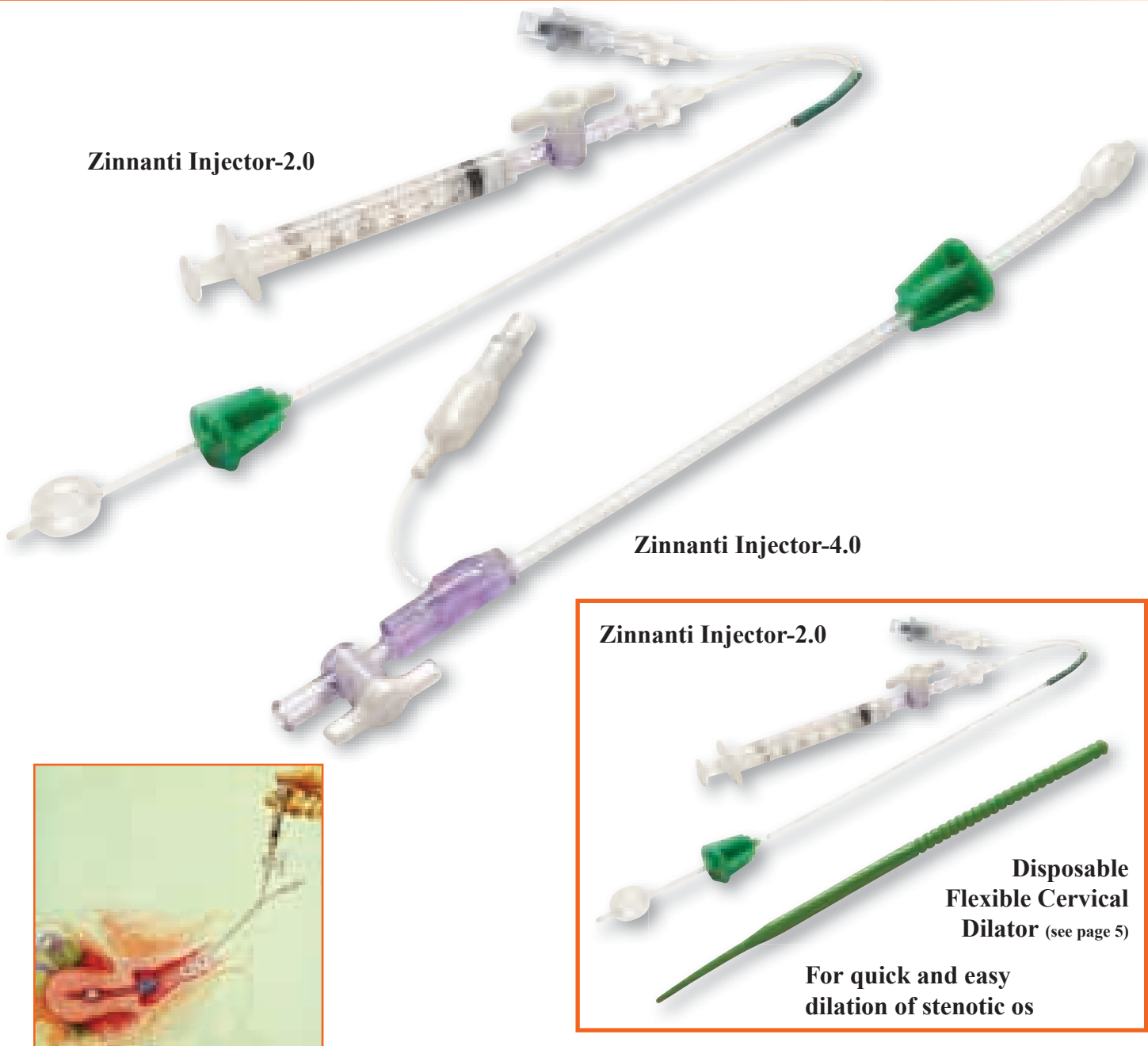

**TMI1153: Zinnanti Injector-2.0, Box of 12
(Includes 2 Disposable Flexible Cervical Dilators)**

TMI1152: Zinnanti Injector-4.0, Box of 12

LATEX FREE

- Sterile...Disposable...Ready to Use
- Shaft curved properly (uterine sound shaped) for use in anteverted or retroverted uteri (4mm only)
- Centimeter depth markings for cervical stop guide (4mm only)
- Snap-on cervical stop custom set for every patient
- Snap-on cervical stop V-shaped design for easy view of external cervical os
- Patient ambulatory once instrument properly inserted
- Durable "no-crack" luer fitting on flexible collar for convenient injection
- No spring or weights added



TMI1175 Zinnanti Sampler - Endometrial Suction Curette

LATEX FREE

- Malleable, non-metallic instruments
- Blunt tip
- Centimeter markings on the curette
- Solid tapered tip and minimum outer diameter combine for safe and comfortable introduction
- Super suction and sharp curette opening ensures a reliable sample collection
- Optimal sample retrieval
- Single use
- Firm, flexible cannula prevents kinking on insertion
- Small outer diameter simplifies introduction
- Box of 25 also includes 2 Disposable Flexible Cervical Dilators

Also available:

Disposable Flexible Cervical Dilators (Os Finders)

OS-01-025 - Box of 25

OS-01-050 - Box of 50



Disposable Uterine Sounds

US-01-025 - Box of 25

Tischler Biopsy Forceps, Spring Handle

- BF-10-800** Standard 3mm x 7mm Jaw, 20.5cm (8")
- BF-02-100** Standard 3mm x 7mm Jaw, 25.5cm (10")
- BF-25-800** Radiance Standard 3mm x 7mm Jaw, 20.5cm (8")
- BF-25-100** Radiance Standard 3mm x 7mm Jaw, 25.5cm (10")



Baby Tischler Biopsy Forceps, Spring Handle

- BF-11-800** Baby 2mm x 4mm Jaw, 20.5cm (8")
- BF-03-100** Baby 2mm x 4mm Jaw, 25.5cm (10")
- BF-26-800** Radiance Baby 2mm x 4mm Jaw, 20.5cm (8")
- BF-26-100** Radiance Baby 2mm x 4mm Jaw, 25.5cm (10")

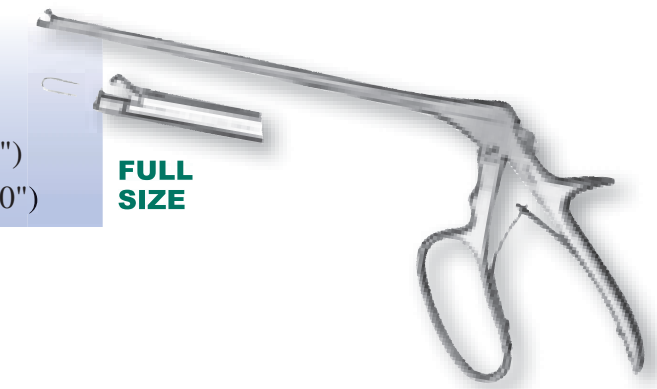

Burke Biopsy Forceps, Spring Handle

- BF-01-800** Standard 3mm x 7mm Jaw, 20.5cm (8")

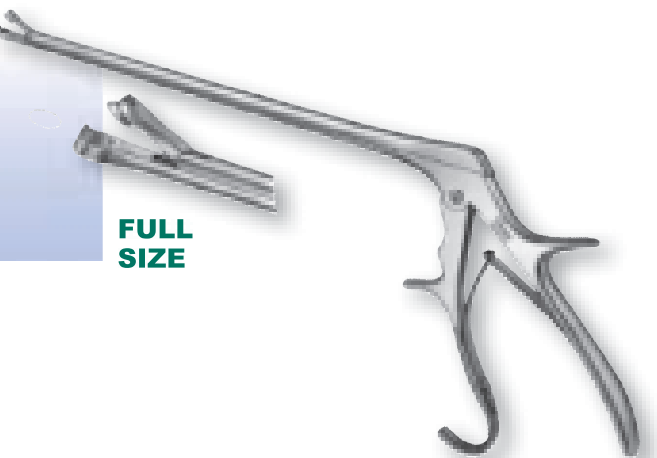

**Radiance: Never Needs Sharpening
Special Titanium Coated**

Kevorkian Biopsy Forceps

BF-07-100 Spring Handle 3mm x 10mm Jaw, 25.5cm (10")

BF-06-110 Standard 3mm x 6mm Jaw, 28cm (11")

**FULL
SIZE**

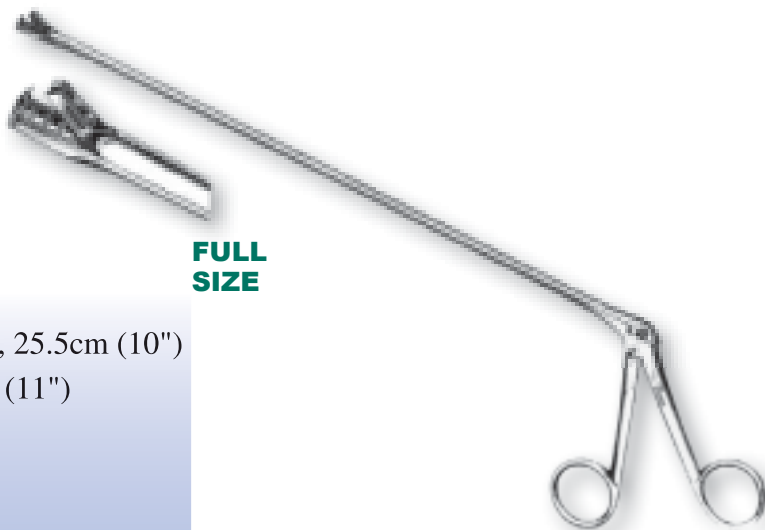

Wittner Biopsy Forceps

BF-16-900 Straight, 23cm (9")

BF-17-900 Curved, 23cm (9")

**FULL
SIZE**

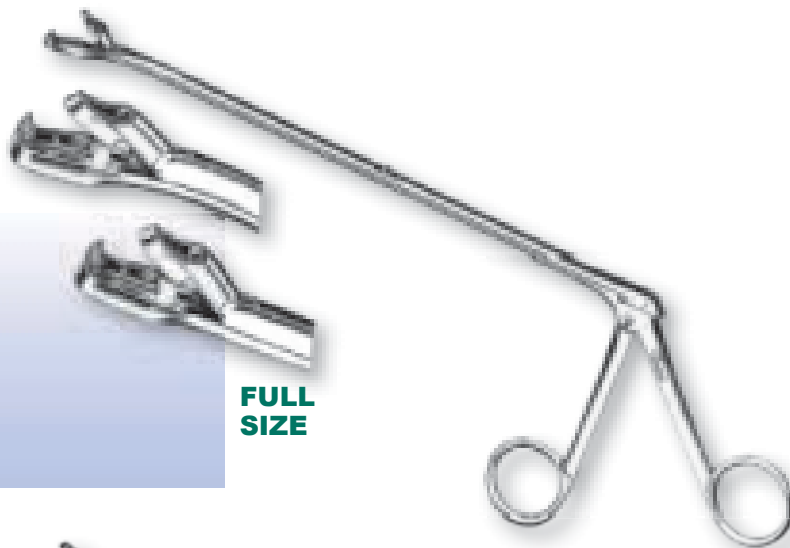

Eppendorfer Biopsy Forceps

BF-18-900 Standard, 23cm (9")

**FULL
SIZE**





Roto-Fit Biopsy Forceps

- BF-12-115** Tischler, Standard, Complete with Roto-Fit Handle, 3mm x 6mm Jaw, 29cm (11.5")
- BF-13-100** Tischler Roto-Fit Shaft Only, 3mm x 6mm Jaw, 25.5cm (10")
- BF-14-115** Baby Tischler, Complete with Roto-Fit handle, 2mm x 4mm Jaw, 29cm (11.5")
- BF-15-100** Baby Tischler Roto-Fit Shaft Only, 2mm x 4mm Jaw, 25.5cm (10")
- BF-08-115** Kevorkian, Standard, Complete with Roto-Fit Handle, 3mm x 10mm Jaw, 29cm (11.5")
- BF-09-100** Kevorkian Roto-Fit Shaft Only, 3mm x 10mm Jaw, 25.5cm (10")
- BF-20-100** Eppendorfer Roto-Fit Shaft Only, 3mm x 6mm Jaw, 25.5cm (10")
- BF-21-000** Roto-Fit Handle Only

Schubert Biopsy Forceps

- BF-04-110** Side Curved, 28cm (11")
- BF-05-110** Straight, 28cm (11")

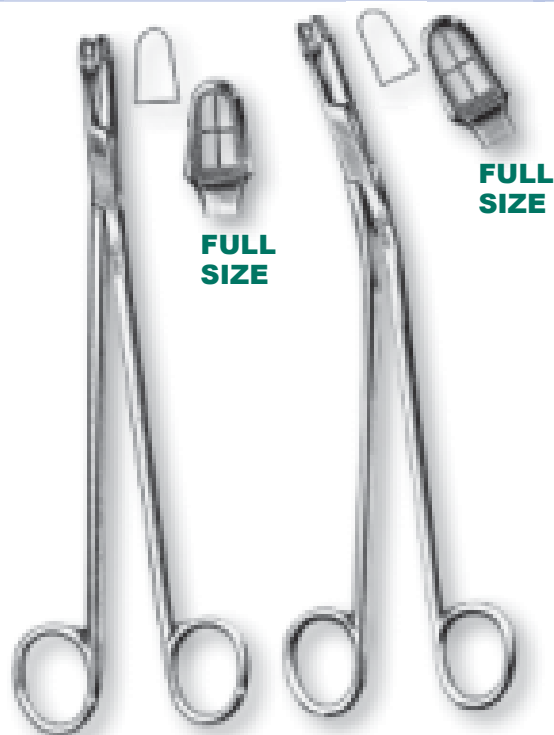

Endometrial/Endocervical Curettes

Not Shown:

EC-09-120 Duncan Curette, Rounded Tip without Basket, 30cm (11.75")

EC-10-120 Duncan Curette, Rounded Tip with Basket, 30cm (11.75")

EC-04-120 Kevorkian Curette with Basket, Rigid, 30cm (11.75")

PLUS **EC-04-140** Kevorkian Curette with Basket, Rigid, 35.5cm (14")

EC-05-120 Kevorkian Curette without Basket, Rigid, 30cm (11.75")

EC-06-120 Kevorkian Curette, Miniature, without Basket, 30cm (11.75")

EC-07-120 Kevorkian Curette without Basket, Malleable, 30cm (11.75")

EC-08-120 Kevorkian Curette with Basket, Malleable, 30cm (11.75")

EC-11-004 Novak Endometrial Curette, 4mm, 23.5cm (9.25")

EC-11-001 Novak Endometrial Curette, 1mm, 23.5cm (9.25")

EC-11-002 Novak Endometrial Curette, 2mm, 23.5cm (9.25")

EC-11-003 Novak Endometrial Curette, 3mm, 23.5cm (9.25")

EC-01-950 Heaney Curette, Malleable, 24cm (9.50")

EC-02-950 Heaney Curette, with Basket, Malleable, 24cm (9.50")

EC-14-925 Randall Curette, 4mm, 23.5cm (9.25")

EC-15-925 Randall Curette, 3mm, 23.5cm (9.25")

EC-16-925 Randall Curette, 2mm, 23.5cm (9.25")



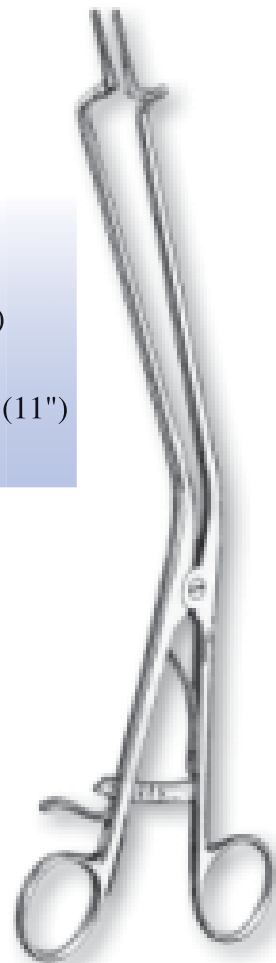

Endocervical Specula

-  **ES-01-140** Kogan Endocervical Speculum with Ratchet, Standard, 35.5cm (14")
- ES-01-110** Kogan Endocervical Speculum with Ratchet, Standard, 28cm (11")
- ES-02-110** Kogan Endocervical Speculum with Ratchet, Narrow Tips, 28cm (11")
- ES-03-110** Kogan Endocervical Speculum without Locking Handle, 28cm (11")
- ES-04-110** Kogan Endocervical Speculum with Ratchet, Angled, Standard, 28cm (11")
- ES-05-110** Kogan Endocervical Speculum without Gauge, Standard, 28cm (11")



- ES-05-950** Kogan Endocervical Speculum with Set Screw, Standard, 25cm (9.5")
- ES-06-950** Kogan Endocervical Speculum with Set Screw, Narrow Tips, 25cm (9.5")

Vaginal Specula

- VS-07-300** Graves Speculum Small, 7.5cm x 2cm (3" x .75")
- VS-07-400** Graves Speculum Medium, 10cm x 4cm (4" x 1.5")
-  **VS-07-475** Graves Speculum Large, 12cm x 4cm (4.75" x 1.5")
-  **VS-07-600** Graves Speculum Supersize, 16cm x 4cm (6.5" x 1.5")
- VS-07-700** Graves Speculum Supersize XL, 7" Long Blade
- VS-02-400** Graves ZED-MORE Speculum Medium, 10cm x 4cm (4" x 1.5")
- VS-02-475** Graves ZED-MORE Speculum Large, 12cm x 4cm (4.75" x 1.5")
- VS-03-375** Graves ZED-MORE XL Speculum Extra Large, 12cm x 4cm (4.75" x 1.5")
- VS-05-400** Miya Hook Speculum Notched, 10cm (4")
- VS-32-400** Radiance Graves Speculum, Medium, Size, 10cm x 4cm (4" x 1.5")
- VS-32-475** Radiance Graves Speculum, Large, Size, 11.5cm x 4cm (4.75" x 1.5")

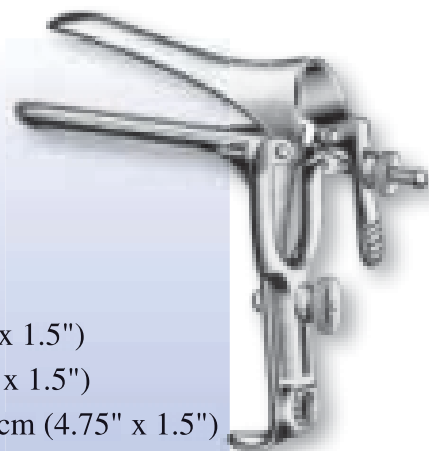

- VS-10-300** Pederson Speculum Virgin, 7.5cm x 1.5cm (3" x .5")
- VS-10-400** Pederson Speculum Medium, 10cm x 2.5cm (4" x 1")
- VS-10-450** Pederson Speculum Large, 11.5cm x 2.5cm (4.5" x 1")
- VS-11-450** Pederson Speculum Extra Narrow, 11.5cm x 1.5cm (4.5" x 9/16")
-  **VS-11-600** Pederson Speculum Extra Long, 6" Long Blade
-  **VS-11-700** Pederson Speculum Supersize XL, 7" Long Blade
- VS-33-400** Radiance Pederson Speculum Medium, Size, 10cm x 2.5cm (4" x 1")
- VS-33-450** Radiance Pederson Speculum Large, Size, 11.5cm x 2.5cm (4.5" x 1")
- VS-08-475** Weisman-Graves Speculum Large, Left Opening, 12cm x 4cm (4.75" x 1.5")
- VS-08-400** Weisman-Graves Speculum Medium, Left Opening, 10cm x 4cm (4" x 1.5")
- VS-08-300** Weisman-Graves Speculum Small, Left Opening, 7.5cm x 2cm (3" x .75")
- VS-09-475** Weisman-Graves Speculum Large, Right Opening, 12cm x 4cm (4.75" x 1.5")
- VS-09-400** Weisman-Graves Speculum Medium, Right Opening, 10cm x 4cm (4" x 1.5")
- VS-09-300** Weisman-Graves Speculum Small, Right Opening, 7.5cm x 2cm (3" x .75")

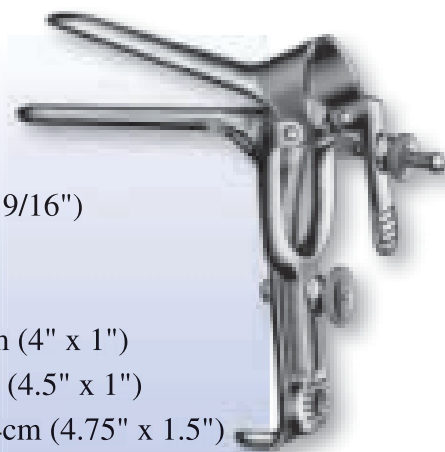

- VS-20-400** Weisman-Pederson Speculum, Medium, Left Opening, 10cm x 4cm (4" x 1")
- VS-21-400** Weisman-Pederson Speculum, Medium, Right Opening, 10cm x 4cm (4" x 1")
- VS-20-450** Weisman-Pederson Speculum, Large, Left Opening, 11.5cm x 4cm (4.5" x 1")
- VS-21-450** Weisman-Pederson Speculum, Large, Right Opening, 11.5cm x 4cm (4.5" x 1")

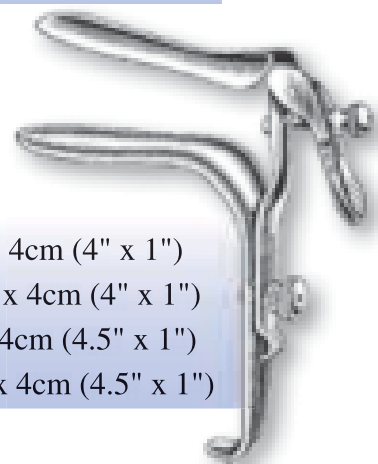

Vaginal Specula

- VS-01-350** Collin Vaginal Speculum Small, 8.5cm x 3cm (3.5" x 1")
- VS-01-400** Collin Vaginal Speculum Medium, 10cm x 3.5cm (4" x 1.5")
- VS-01-450** Collin Vaginal Speculum Large, 11cm x 4.5cm (4.5" x 1.75")

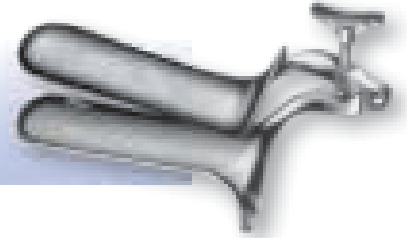

- VS-04-375** Cusco Vaginal Speculum Extra Small, 7.5cm x 2cm (3" x .75")
- VS-04-312** Cusco Vaginal Speculum Small, 7.5cm x 3cm (3" x 1.25")
- VS-04-351** Cusco Vaginal Speculum Medium, 9cm x 3cm (3.5" x 1.25")
- VS-04-415** Cusco Vaginal Speculum Large, 10cm x 4cm (4" x 1.5")



- VS-14-350** Guttman Vaginal Speculum, Solid Center Blade, 9cm x 4cm (3.5" x 1.5")
- VS-15-350** Guttman Vaginal Speculum, Solid Center Blades, 9cm x 3cm (3.5" x 1.25")

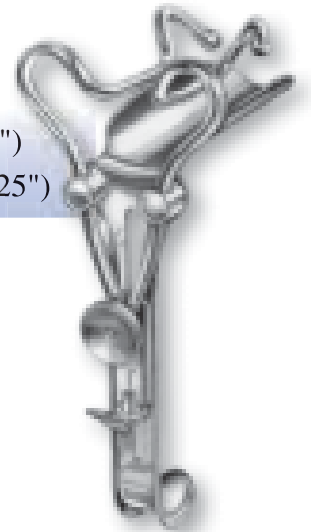

- VS-16-300** Guttman Obstetrical Retractor Small, 7.5cm (3") Blades
- VS-16-425** Guttman Obstetrical Retractor Large, 11cm (4.25") Blades



Not Pictured:

- VS-30-300** Greenberg Hyteroscopy Speculum, Left Opening
- VS-31-300** Greenberg Hyteroscopy Speculum, Right Opening

Vaginal Specula

VS-13-100 O'Connor-O'Sullivan Speculum, Complete with 3 Blades,
1.5cm x 5cm, 4cm x 9cm, 4.5cm x 9cm
(.5" x 2", 1.5" x 3.5", 1.75" x 3.5")

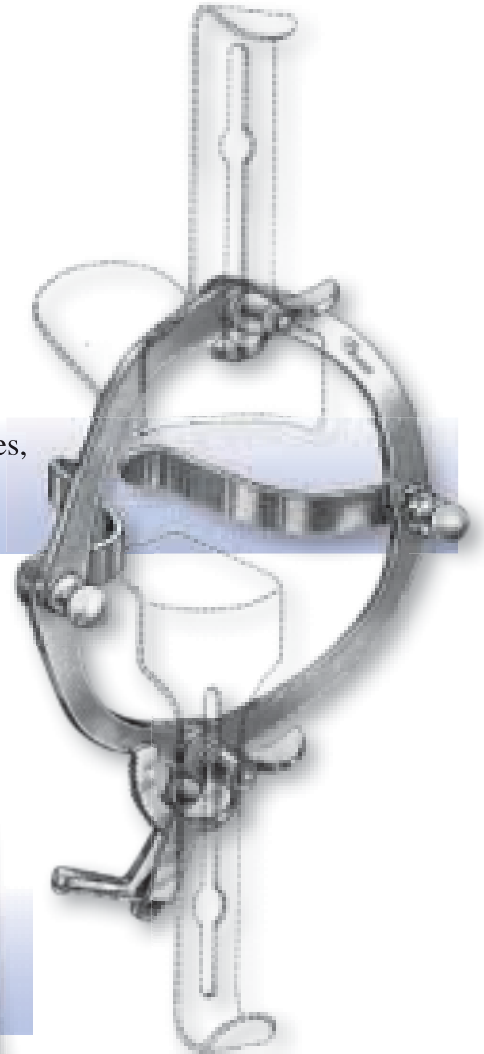

VS-17-200 Lateral Vaginal Retractor; Blade Size 2" long

VS-17-300 Lateral Vaginal Retractor; Blade Size 3"

VS-17-450 Lateral Vaginal Retractor; Blade Size 4.5" long

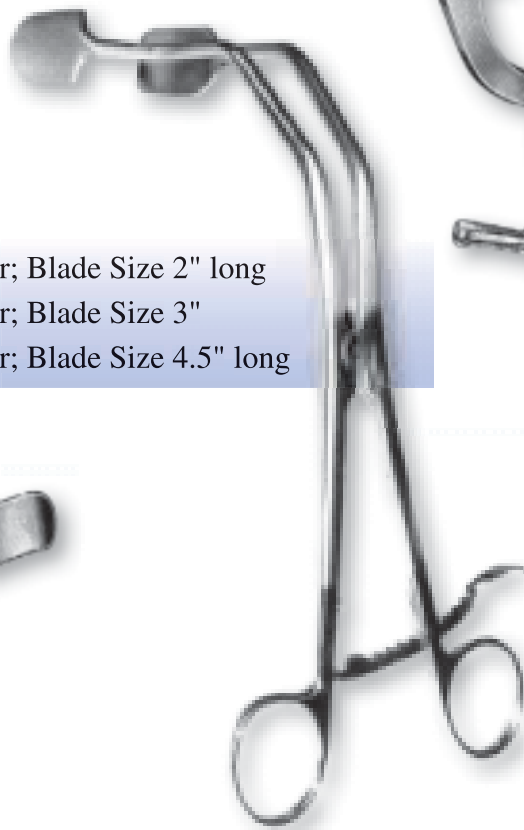

VS-12-700 Wall Retractor (RWR), 9cm x 2cm
(3.5" x .75") Blades, 18cm (7")

Weighted Specula

WS-04-550 Steiner Speculum, 1.1Kg (2.5 lbs), 14cm x 3 cm (5.5" x 1.25")

WS-04-600 Frank Speculum, 1.1Kg (2.5 lbs), 14cm x 3 cm (5.5" x 1.25")
(Same As Steiner Speculum without Side Wings)

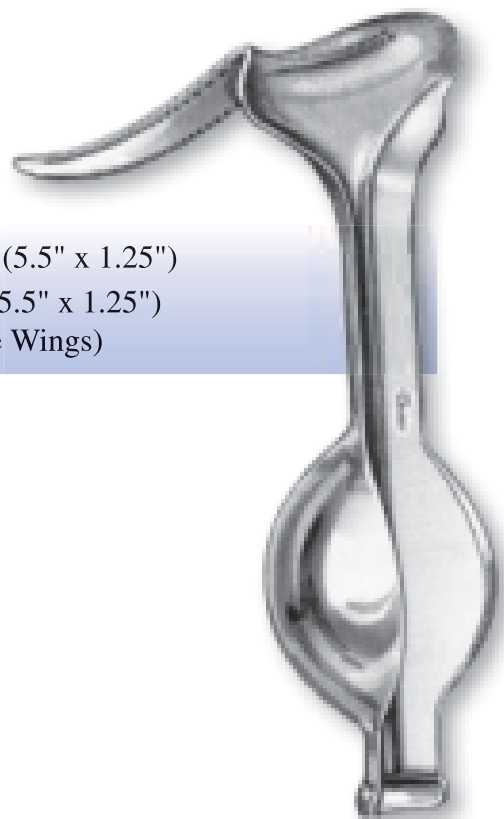

WS-01-275 Auvard Speculum, 1.1Kg (2.5 lbs), 6.5cm x 4cm (2.75" x 1.5")

WS-01-350 Auvard Speculum, 1.1KG (2.5 lbs), 8.5cm x 4cm (3.5" x 1.5")

WS-01-400 Auvard Speculum, 1.1Kg (2.5 lbs), 10cm x 4.5cm (4" x 1.75")

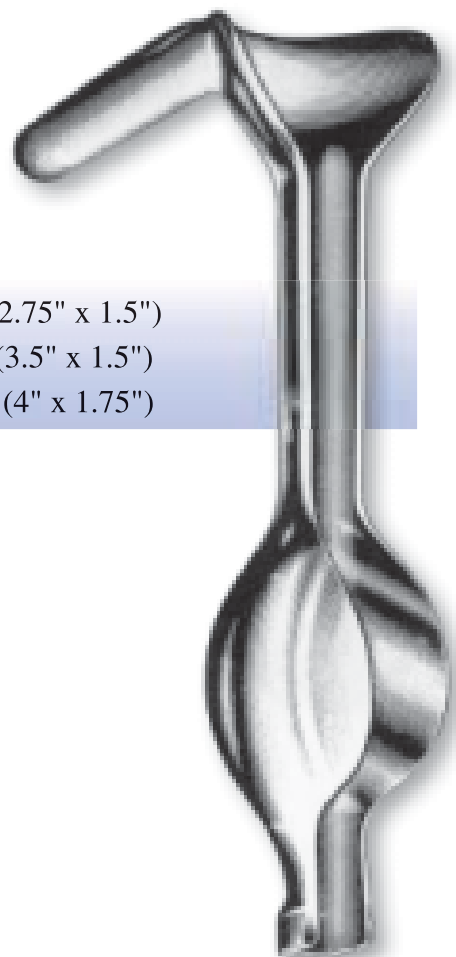

Weighted Specula

WS-05-400 Berlind Speculum, 1.1 Kg (2.5 lbs), 10cm x 4.5cm (4" x 1.75")

WS-06-275 Berlind Speculum, 1.4 Kg (3 lbs), 6.5cm x 4.5cm (2.75" x 1.5")

WS-06-400 Berlind Speculum, 1.4 Kg (3 lbs), 10cm x 4.5cm (4" x 1.75")

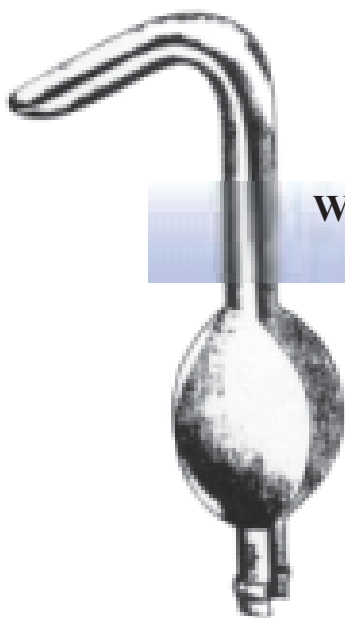

WS-07-325 Henrotin Vaginal Speculum, 1.4 Kg (3 lbs),
8.5cm x 4 cm (3.25" x 1.5")

WS-02-300 Garrique Speculum, 1.1 Kg (2.5 lbs), 7.5cm x 4cm (3" x 1.5")

WS-03-300 Garrique Speculum, 1.4 Kg (3 lbs), 7.5cm x 4cm (3" x 1.5")



Vaginal Retractors

- VR-04-005** Breisky Retractor, 10cm x 1.8cm (4" x .5") Blade
- VR-04-100** Breisky Retractor, 10cm x 2.5cm (4" x 1") Blade
- VR-04-125** Breisky Retractor, 10cm x 3cm (4" x 1.25") Blade
- VR-04-130** Breisky Retractor, 10cm x 3.5cm (4" x 1.3") Blade
- VR-04-150** Breisky Retractor, 10cm x 3.8cm (4" x 1.5") Blade
- VR-05-450** Breisky Retractor, 12cm x 3cm (4.5" x 1.25") Blade
- VR-05-530** Breisky Retractor, 13cm x 3.5cm (5.3" x 1.3") Blade
- VR-05-550** Breisky Retractor, 14cm x 3.5cm (5.5" x 1.3") Blade
- VR-05-600** Breisky Retractor, 15cm x 3.5cm (6" x 1.3") Blade
- VR-05-625** Breisky Retractor, 16cm x 3.5cm (6.25" x 1.3") Blade
- VR-08-675** Breisky-Navratil Retractor, 17cm x 2.5cm (6.75" x 1") Blade



- VR-01-300** Sims Speculum Small, Double Ended, 2.5cm x 4.5cm and 3cm x 7.5cm (1" x 2.5" and 1.25" x 3)
- VR-01-325** Sims Speculum Medium, Double Ended 3cm x 7.5cm and 4cm x 8.5cm (1.25" x 3" and 1.5" x 3.25")
- VR-01-400** Sims Speculum Large, Double Ended, 4cm x 8.5cm and 4.5cm x 10cm (1.5" x 3.25" and 1.75" x 4")

- VR-07-100** Sims Retractor Small, 2.5cm x 6cm (1" x 2.5")
- VR-07-125** Sims Retractor Medium, 3cm x 7.5cm (1.25" x 3")
- VR-07-150** Sims Retractor Large, 4cm x 10cm (1.5" x 4")

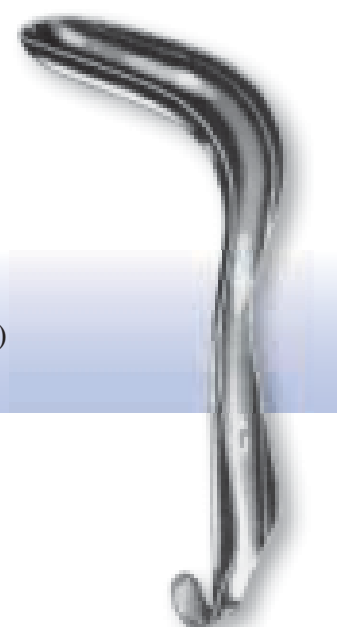

Vaginal Retractors

- VR-09-105** Heaney Retractor Small, 4.5cm x 2.5cm (1.75" x 1") Blade, 27cm (10.5")
- VR-09-675** Heaney Retractor Med., 4.5cm x 2.5cm (1.75" x 1") Blade, 17cm (6.75")
- VR-10-105** Heaney Retractor Large, 7.3cm x 2.8cm (2.75" x 1.25") Blade, 27cm (10.5")
- VR-10-750** Heaney Retractor Med., 7.3cm x 2.8cm (2.75" x 1.25") Blade, 19cm (7.5")
- VR-11-105** Heaney Retractor Large, 8.3cm x 2.8cm (3.25" x 1.1") Blade, 27cm (10.5")
- VR-11-675** Heaney Retractor Large, 8.3cm x 2.8cm (3.25" x 1.1") Blade, 17cm (6.75")

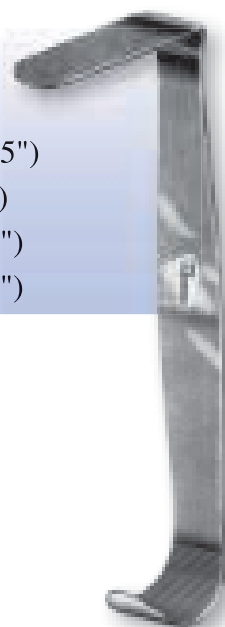

- VR-03-300** Eastman Retractor Small, 7.6cm x 8cm (3" x 1.5")
- VR-03-350** Eastman Retractor Medium, 8.9cm x 3.8cm (3.5" x 1.5")
- VR-03-400** Eastman Retractor Large, 10.2cm x 3.8cm (4" x 1.5")

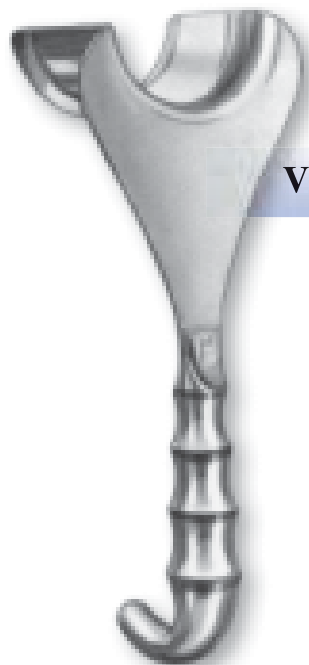

- VR-02-950** DeLee Retractor, Universal, 24cm (9.5")

- VR-06-300** Jackson Speculum Small, 7.6cm x 3.8cm (3" x 1.5")
- VR-06-350** Jackson Speculum Medium, 8.9cm x 3.8cm (3.5" x 1.5")
- VR-06-400** Jackson Speculum Large, 10.2cm x 3.8cm (4" x 1.5")

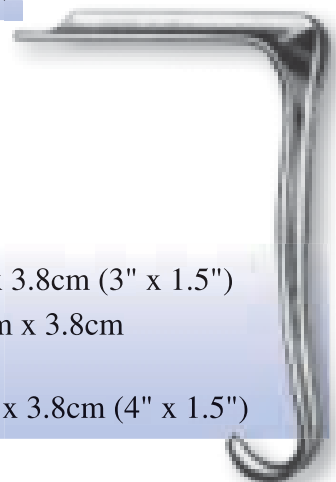

Uterine Dilators

Reusable Teflon Dilators - Autoclavable

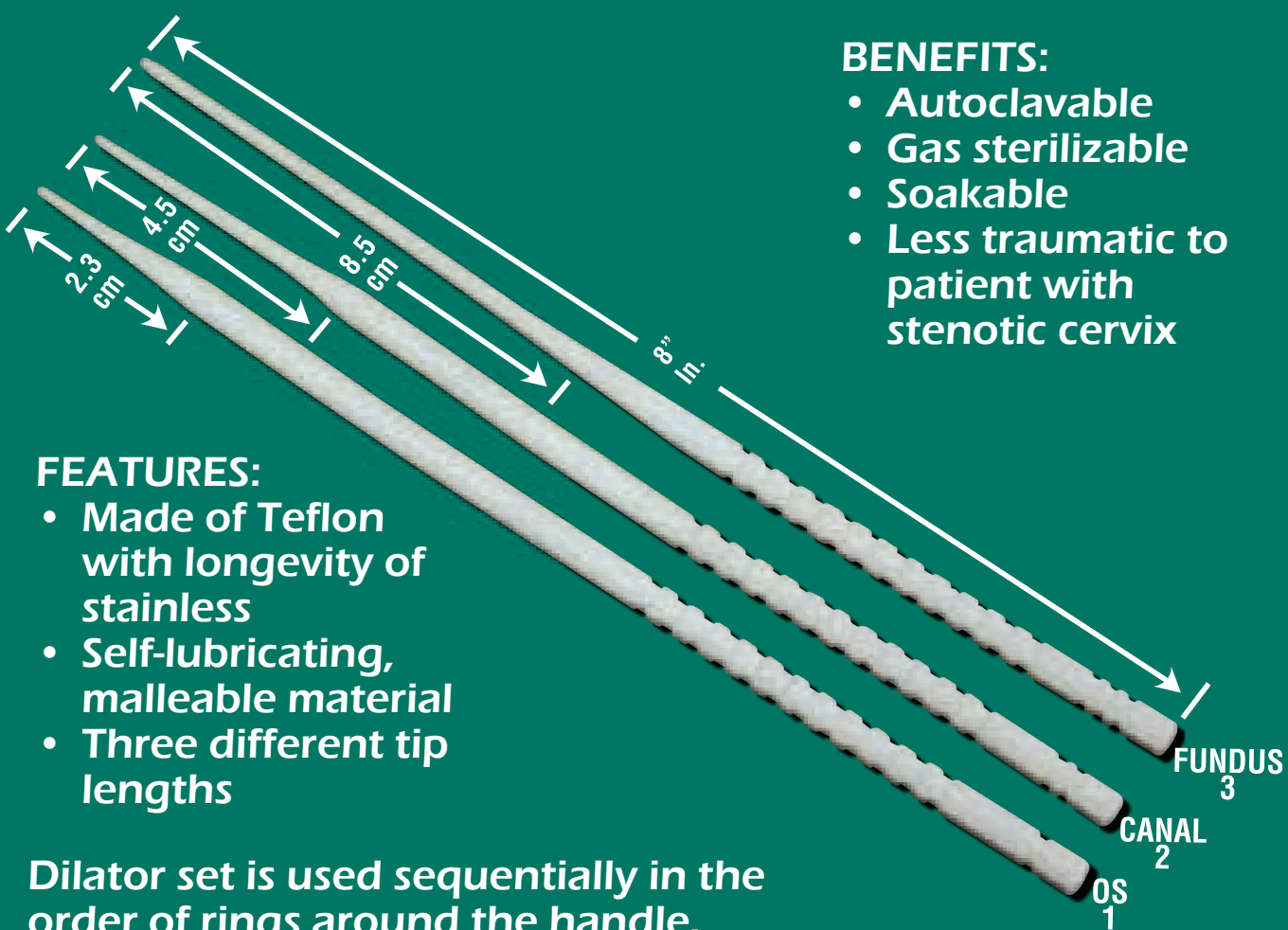

BENEFITS:

- Autoclavable
- Gas sterilizable
- Soakable
- Less traumatic to patient with stenotic cervix

FEATURES:

- Made of Teflon with longevity of stainless
- Self-lubricating, malleable material
- Three different tip lengths

Dilator set is used sequentially in the order of rings around the handle.

- FD-01-100** Cervical Os Finder, Single Ended, Diameter 1.75mm to 3.8mm, Depth 2.3cm, Length 20cm (8")
- FD-01-200** Uterine Canal Finder, Single Ended, Diameter 1.75mm to 3.8mm, Depth 4.5cm, Length 20cm (8")
- FD-01-300** Uterine Cavity Finder, Single Ended, Diameter 1.75mm to 3.8mm, Depth 8.5cm, Length 20cm (8")
- FD-01-500** Flexible Dilator Set of 3, Single Ended, Diameter 1.75mm to 3.8mm, Depth 2.3cm to 8.5cm, Length 20cm (8")

Mini Cervical Dilator Set

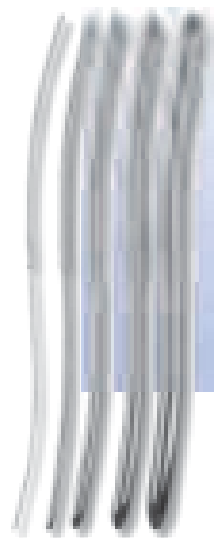

Pratt Mini Dilator Set

UD-08-100:

Double Ended

- Sizes: 1mm x 2mm
3mm x 4mm
5mm x 6mm
7mm x 8mm
9mm x 10mm
- Stainless Steel

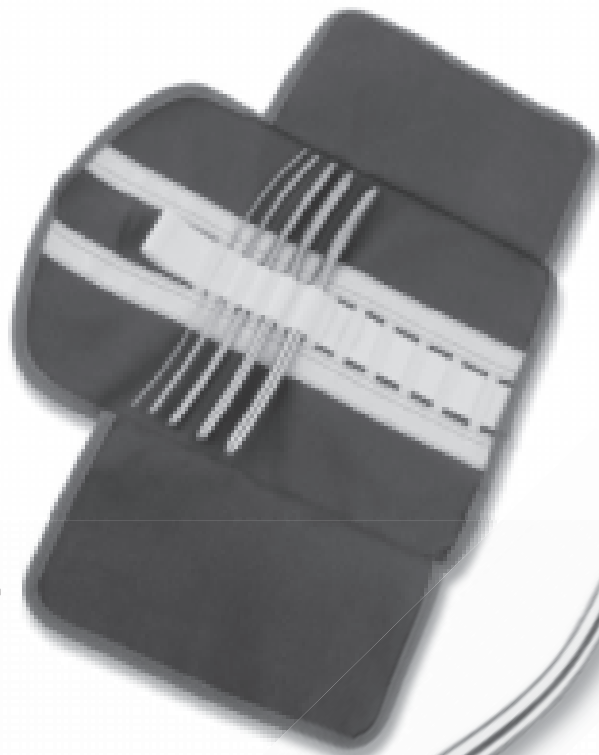

UD-08-100 KIT

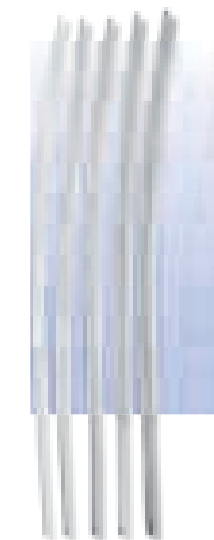

Pratt Mini Dilator Set

UD-07-100:

Single Ended

- Sizes: 1.0mm
1.5mm
2.0mm
2.5mm
3.0mm
- Stainless Steel

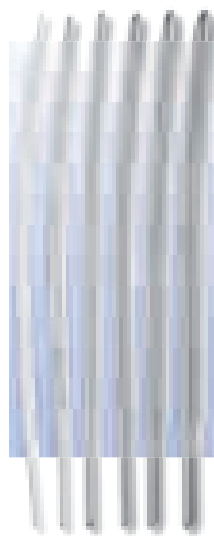

Mini Dilator Set

UD-06-100:

Single Ended

- Sizes: 1.0mm
2.0mm
3.0mm
4.0mm
5.0mm
6.0mm
- Stainless Steel



Kleegman Dilators

UD-03-110

- Sizes: Less than 1mm-3mm at the tips

FRENCH SCALE fr/mm

3 fr	1.0mm	11 fr	3.7mm	20 fr	6.7mm
4 fr	1.3mm	12 fr	4.0mm	22 fr	7.3mm
5 fr	1.7mm	13 fr	4.3mm	24 fr	8.0mm
6 fr	2.0mm	14 fr	4.7mm	26 fr	8.7mm
7 fr	2.3mm	15 fr	5.0mm	28 fr	9.3mm
8 fr	2.7mm	16 fr	5.3mm	30 fr	10.0mm
9 fr	3.0mm	17 fr	5.7mm	32 fr	10.7mm
10 fr	3.3mm	18 fr	6.0mm	34 fr	11.3mm
		19 fr	6.3mm		

Not Pictured:

UD-09-100 Mini Dilator Set with Removable Handle, Single Ended; Size: 1mm, 1.5mm, 2mm, 2.5mm, 3mm

- UD-04-100** Pratt Dilators, Set of 8, Double Ended, 13/15Fr to 41/43Fr, 29cm (11.5")
- UD-04-315** Pratt Dilator, Double Ended, 13/15Fr, 29cm (11.5")
- UD-04-719** Pratt Dilator, Double Ended, 17/19Fr, 29cm (11.5")
- UD-04-123** Pratt Dilator, Double Ended, 21/23Fr, 29cm (11.5")
- UD-04-527** Pratt Dilator, Double Ended, 25/27Fr, 29cm (11.5")
- UD-04-931** Pratt Dilator, Double Ended, 29/31Fr, 29cm (11.5")
- UD-04-335** Pratt Dilator, Double Ended, 33/35Fr, 29cm (11.5")
- UD-04-739** Pratt Dilator, Double Ended, 37/39Fr, 29cm (11.5")
- UD-04-143** Pratt Dilator, Double Ended, 41/43Fr, 29cm (11.5")
- UD-04-547** Pratt Dilator, Double Ended, 45/47Fr, 29cm (11.5")
- UD-04-951** Pratt Dilator, Double Ended, 49/51Fr, 29cm (11.5")
- UD-04-355** Pratt Dilator, Double Ended, 53/55Fr, 29cm (11.5")
- UD-04-759** Pratt Dilator, Double Ended, 57/59Fr, 29cm (11.5")
- UD-08-100** Pratt Mini Dilator Set of 5, Double Ended; Size; 1-2mm, 3-4mm, 5-6mm, 7-8mm, 9-10mm

Pratt Dilator

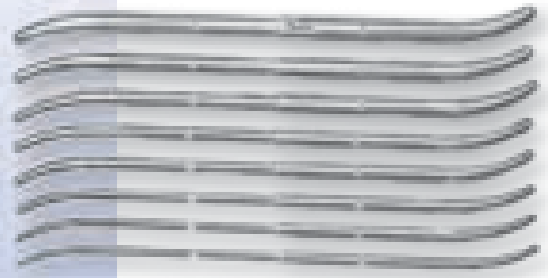

- UD-01-100** Hegar Dilators, Set of 8, Double Ended, 3/4mm to 17/18mm, 19cm (7.5")
- UD-01-012** Hegar Dilator, Double Ended, 1/2mm, 19cm (7.5")
- UD-01-034** Hegar Dilator, Double Ended, 3/4mm, 19cm (7.5")
- UD-01-056** Hegar Dilator, Double Ended, 5/6mm, 19cm (7.5")
- UD-01-078** Hegar Dilator, Double Ended, 7/8mm, 19cm (7.5")
- UD-01-910** Hegar Dilator, Double Ended, 9/10mm, 19cm (7.5")
- UD-01-111** Hegar Dilator, Double Ended, 11/12mm, 19cm (7.5")
- UD-01-131** Hegar Dilator, Double Ended, 13/14mm, 19cm (7.5")
- UD-01-151** Hegar Dilator, Double Ended, 15/16mm, 19cm (7.5")
- UD-01-171** Hegar Dilator, Double Ended, 17/18mm, 19cm (7.5")

Hegar Dilator

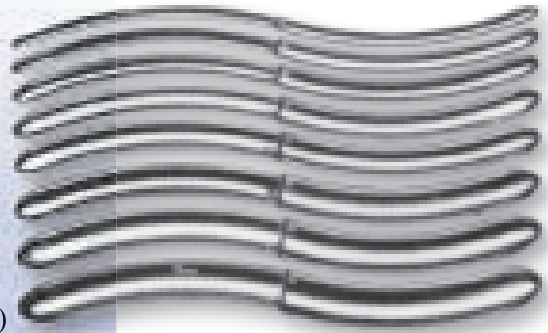

- UD-02-100** Hank Dilators, Set of 6, Double Ended, 9/10Fr to 19/20Fr, 26cm (10.25")
- UD-02-910** Hank Dilator, Double Ended, 9/10Fr, 26cm (10.25")
- UD-02-112** Hank Dilator, Double Ended, 11/12Fr, 26cm (10.5")
- UD-02-314** Hank Dilator, Double Ended, 13/14Fr, 26cm (10.5")
- UD-02-516** Hank Dilator, Double Ended, 15/16Fr, 26cm (10.25")
- UD-02-171** Hank Dilator, Double Ended, 17/18Fr, 26cm (10.25")
- UD-02-192** Hank Dilator, Double Ended, 19/20Fr, 26cm (10.25")

Hank Dilators

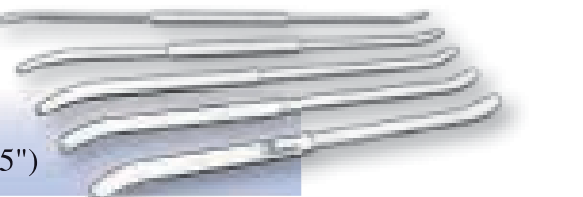

- UD-05-100** Denniston Dilators, Set of 5, Double Ended, Autoclavable Teflon, 5/6mm to 13/14mm, 29cm (11.5")

Dilators/Sounds



DS-01-125 Sims Dilator / Sound, Graduated in Centimeters, Malleable, 32cm (12.5")

DS-02-125 Sims Dilator / Sound, Graduated in Inches, 32cm (12.5")

DS-07-125 Sims Dilator / Sound, Plain, 32cm (12.5")



DS-03-125 Simpson Dilator / Sound, Graduated in Centimeters, 32cm, (12.5")

DS-05-125 Simpson Dilator / Sound, Graduated in Inches, 32cm, (12.5")

IUD Hooks



IH-03-105 Double IUD Extractor, 26cm (10.5")

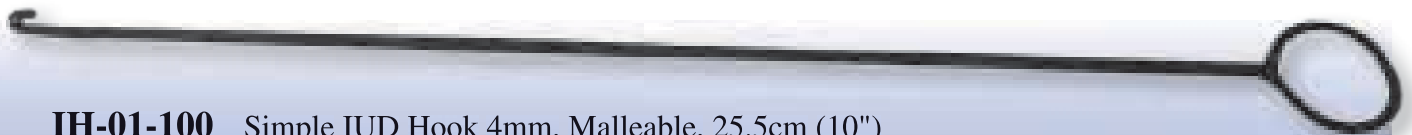

IH-01-100 Simple IUD Hook 4mm, Malleable, 25.5cm (10")



IH-02-100 Universal IUD Hook 4mm, 25.5cm (10")

OB/GYN Hooks

- GH-04-001** Emmett Hook #1, Full Curve, 23cm (9")
- GH-04-002** Emmett Hook #2, Acute Curve, 23cm (9")
- GH-04-003** Emmett Hook #3, Right Angle, 23cm (9")
- GH-04-004** Emmett Hook #4, Curved, 23cm (9")
- GH-04-005** Emmett Hook #5, Double Angled, 23cm (9")
- GH-05-004** Emmett Hook #4, Round Handle, Curved, 23cm (9")
- GH-05-005** Emmett Hook #5, Round Handle, Double Angled, 23cm (9")



- GH-03-925** Iris Hook, 23.5cm (9.25")
- GH-06-900** Iris Hook, Round Handle, 23cm (9")



- GH-01-800** Adson Nerve Hook Sharp, 20cm (8")
- GH-02-800** Adson Nerve Hook Blunt, 20cm (8")











Not Pictured:

- NE-01-200** Needle Extender; Length: 5cm (2")
- NE-01-300** Needle Extender; Length: 7.5cm (3")
- NE-01-400** Needle Extender; Length: 10cm (4")
- NE-01-500** Needle Extender; Length: 13cm (5")
- NE-01-600** Needle Extender; Length: 15cm (6")

Uterine Curettes

- UC-02-003** Sims Curette #00, 3mm, Sharp, Malleable, 28cm (11")
- UC-02-005** Sims Curette #0, 5mm, Sharp, Malleable, 28cm (11")
- UC-02-007** Sims Curette #1, 7mm, Sharp, Malleable, 28cm (11")
- UC-02-009** Sims Curette #2, 9mm, Sharp, Malleable, 28cm (11")
- UC-02-011** Sims Curette #3, 11mm, Sharp, Malleable, 28cm (11")
- UC-02-013** Sims Curette #4, 13mm, Sharp, Malleable, 28cm (11")
- UC-02-015** Sims Curette #5, 15mm, Sharp, Malleable, 28cm (11")
- UC-02-017** Sims Curette #6, 17mm, Sharp, Malleable, 28cm (11")

-  **UC-03-003** Sims Curette #00, 3mm, Sharp, Malleable, 35.5cm (14")
-  **UC-03-005** Sims Curette #0, 3mm, Sharp, Malleable, 35.5cm (14")
-  **UC-03-007** Sims Curette #1, 3mm, Sharp, Malleable, 35.5cm (14")
-  **UC-03-009** Sims Curette #2, 3mm, Sharp, Malleable, 35.5cm (14")
-  **UC-03-011** Sims Curette #3, 3mm, Sharp, Malleable, 35.5cm (14")
-  **UC-03-013** Sims Curette #4, 3mm, Sharp, Malleable, 35.5cm (14")
-  **UC-03-015** Sims Curette #5, 3mm, Sharp, Malleable, 35.5cm (14")
-  **UC-03-017** Sims Curette #6, 3mm, Sharp, Malleable, 35.5cm (14")

- UC-10-003** Radiance Sims Curette, #00, 3mm; 28cm (11")
- UC-10-005** Radiance Sims Curette, #0, 5mm; 28cm (11")



- UC-01-018** Bumm Placenta Curette 18mm, Malleable, 31cm (12.25")
- UC-01-020** Bumm Placenta Curette 20mm, Malleable, 31cm (12.25")
- UC-01-022** Bumm Placenta Curette 22mm, Malleable, 31cm (12.25")
- UC-01-023** Bumm Placenta Curette 23mm, Malleable, 31cm (12.25")

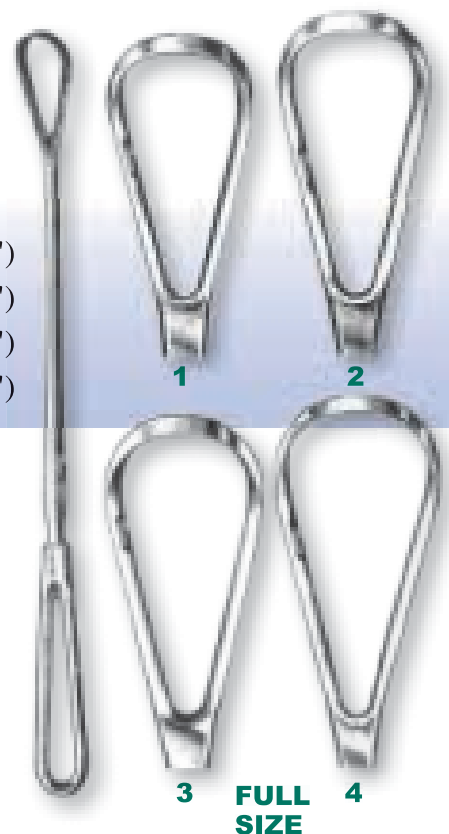

***Radiance: Never Needs Sharpening
Special Titanium Coated***

Tenaculum Forceps



**FULL
SIZE**

TV-03-100 Schroeder Tenaculum, 25.5cm (10")

 **TV-03-140** Schroeder Tenaculum, 35.5cm (14")

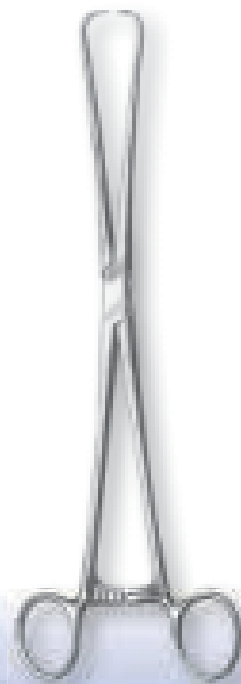

TV-04-100 Atraumatic Tenaculum 6mm Jaw, 25.5cm (10")

TV-05-100 Atraumatic Tenaculum 4mm Jaw, 25.5cm (10")

TV-06-100 Atraumatic Cervical Tenaculum, Angled, 25.5cm (10")



TV-07-100 Braun Tenaculum, 25.5cm (10")



TV-01-700 Barrett Tenaculum, 18cm (7")



Tenaculum/Vulsellum Forceps



TV-02-675 Staude-Moore Tenaculum, 17cm (6.75")

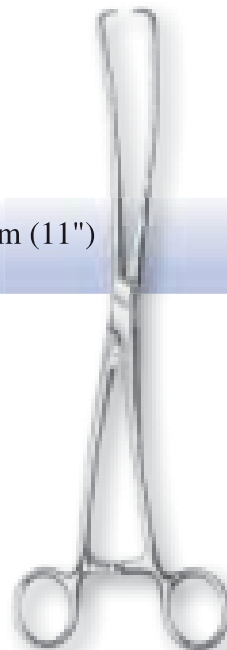

TV-08-110 Duplay Tenaculum, 28cm (11")

TV-13-950 Teale Vulsellum Forceps, 24cm (9.5")



TV-12-100 Iowa Vulsellum Forceps, 26cm (10.25")



TV-09-100 Schroeder Vulsellum Forceps, Straight, 25.5cm (10")

TV-10-100 Schroeder Vulsellum Forceps, Curved on Flat, 25.5cm (10")

TV-11-100 Schroeder Vulsellum Forceps, Side Curved, 25.5cm (10")



Vulsellum/Ovum Forceps

- VO-09-110** Bierer Ovum Forceps 16mm Jaw, 28cm (11")
- VO-10-110** Bierer Ovum Forceps 16mm Jaw with Ratchet, 28cm (11")
- VO-11-110** Bierer Ovum Forceps 19mm Jaw, 28cm (11")
- VO-12-110** Bierer Ovum Forceps 19mm Jaw with Ratchet, 28cm (11")

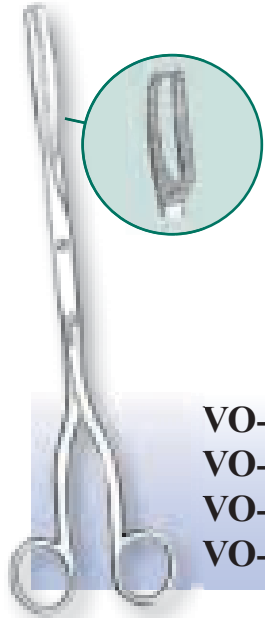
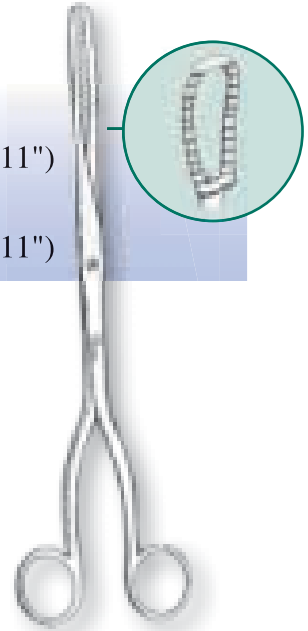

- VO-13-110** Sopher Ovum Forceps 12mm Jaw, 28cm (11")
- VO-14-110** Sopher Ovum Forceps 12mm with Ratchet, 28cm (11")
- VO-15-110** Sopher Ovum Forceps 14mm Jaw, 28cm (11")
- VO-16-110** Sopher Ovum Forceps 14mm Jaw with Ratchet, 28cm (11")

VO-01-950 Corey Ovum Forceps, 24cm (9.5")

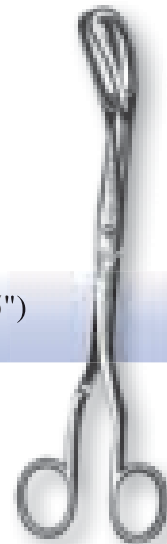

VO-03-100 Forbes Placenta/Ovum Forceps, 25.5cm (10")



Vulsellum/Ovum Forceps

VO-08-120 Kelly Placenta Forceps, 31cm (12.25")



VO-06-100 Barrett Placenta Forceps, 25.5cm (10")

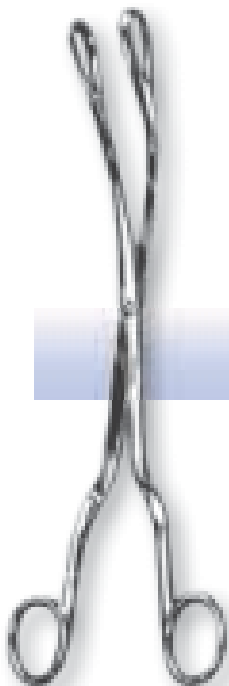

VO-07-950 Javerts Placenta Forceps, 24cm (9.5")



VO-17-925 Desjardin Forceps, Small Jaw, 23.5cm (9.25")

VO-18-925 Desjardin Forceps, Large Jaw, 23.5cm (9.25")



Vulsellum/Ovum Forceps

VO-19-925 Randall Forceps 1/4 Curve, 23.5cm (9.25")

VO-20-925 Randall Forceps 1/2 Curve, 23.5cm (9.25")

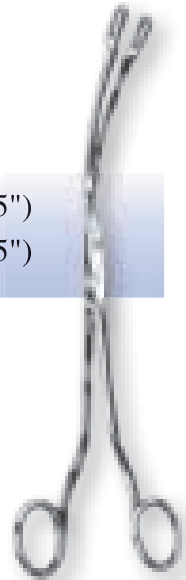

VO-02-900 Kelly Vulsellum Forceps, 5 x 6 Teeth, Side Curved, 23cm (9")



VO-04-850 Jacobs Vulsellum Forceps, Straight, 21cm (8.5")

VO-05-850 Jacobs Vulsellum Forceps, Curved, 21cm (8.5")

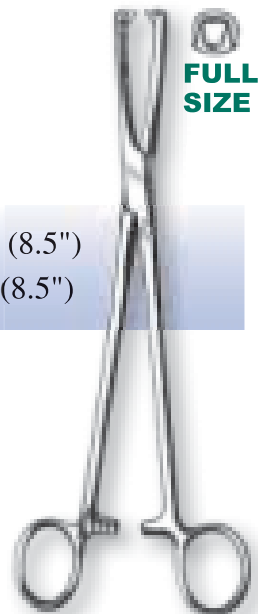

Hysterectomy Forceps

- ZC-01-850** ZED-Clamp Hysterectomy Forceps, Straight, 21.5cm (8.5")
- ZC-01-950** ZED-Clamp Hysterectomy Forceps, Straight, 24cm (9.5")
- +** **ZC-01-120** ZED-Clamp Hysterectomy Forceps, Straight, 30.5cm (12")
- +** **ZC-01-140** ZED-Clamp Hysterectomy Forceps, Straight, 35.5cm (14")

- ZC-02-850** ZED-Clamp Hysterectomy Forceps, Slightly Curved, 21.5cm (8.5")
- ZC-02-950** ZED-Clamp Hysterectomy Forceps, Slightly Curved, 24cm (9.5")
- +** **ZC-02-120** ZED-Clamp Hysterectomy Forceps, Slightly Curved, 30.5cm (12")
- +** **ZC-02-140** ZED-Clamp Hysterectomy Forceps, Slightly Curved, 35.5cm (14")

- ZC-03-850** ZED-Clamp Hysterectomy Forceps, Strongly Curved, 21.5cm (8.5")
- ZC-03-950** ZED-Clamp Hysterectomy Forceps, Strongly Curved, 24cm (9.5")
- +** **ZC-03-120** ZED-Clamp Hysterectomy Forceps, Strongly Curved, 30.5cm (12")
- +** **ZC-03-140** ZED-Clamp Hysterectomy Forceps, Strongly Curved, 35.5cm (14")

- ZC-04-850** ZED-Clamp Hysterectomy Forceps, Angled, 21.5cm (8.5")
- ZC-04-950** ZED-Clamp Hysterectomy Forceps, Angled, 24cm (9.5")
- +** **ZC-04-120** ZED-Clamp Hysterectomy Forceps, Angled, 30.5cm (12")
- +** **ZC-04-140** ZED-Clamp Hysterectomy Forceps, Angled, 35.5cm (14")

- ZC-05-850** ZED-Clamp Hysterectomy Forceps, Straight, Angled Shaft, 21.5cm (8.5")
- ZC-05-950** ZED-Clamp Hysterectomy Forceps, Straight, Angled Shaft, 24cm (9.5")
- +** **ZC-05-120** ZED-Clamp Hysterectomy Forceps, Straight, Angled Shaft, 30.5cm (12")
- +** **ZC-05-140** ZED-Clamp Hysterectomy Forceps, Straight, Angled Shaft, 35.5cm (14")

- ZC-06-850** ZED-Clamp Hysterectomy Forceps, Slightly Curved, Angled Shaft, 21.5cm (8.5")
- ZC-06-950** ZED-Clamp Hysterectomy Forceps, Slightly Curved, Angled Shaft, 24cm (9.5")
- +** **ZC-06-120** ZED-Clamp Hysterectomy Forceps, Slightly Curved, Angled Shaft, 30.5cm (12")
- +** **ZC-06-140** ZED-Clamp Hysterectomy Forceps, Slightly Curved, Angled Shaft, 35.5cm (14")

- ZC-07-850** ZED-Clamp Hysterectomy Forceps, Strongly Curved, Angled Shaft, 21.5cm (8.5")
- ZC-07-950** ZED-Clamp Hysterectomy Forceps, Strongly Curved, Angled Shaft, 24cm (9.5")
- +** **ZC-07-120** ZED-Clamp Hysterectomy Forceps, Strongly Curved, Angled Shaft, 30.5cm (12")
- +** **ZC-07-140** ZED-Clamp Hysterectomy Forceps, Strongly Curved, Angled Shaft, 35.5cm (14")

- ZC-08-850** ZED-Clamp Hysterectomy Forceps, Angled, Angled Shaft, 21.5cm (8.5")
- ZC-08-950** ZED-Clamp Hysterectomy Forceps, Angled, Angled Shaft, 24cm (9.5")
- +** **ZC-08-120** ZED-Clamp Hysterectomy Forceps, Angled, Angled Shaft, 30.5cm (12")
- +** **ZC-08-140** ZED-Clamp Hysterectomy Forceps, Angled, Angled Shaft, 35.5cm (14")

- ZC-10-110** ZED-Clamp Adnexal, 25.5cm (10")
- +** **ZC-11-110** ZED-Clamp Hysterectomy Forceps, Side Curved, 28cm (11")

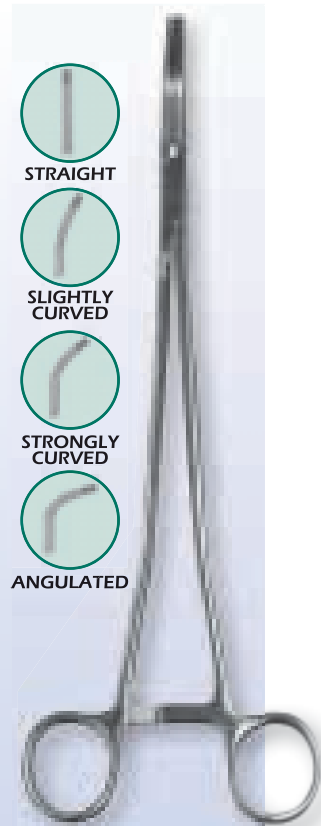

*Also see page 45
for matching scissors*

Hysterectomy Forceps

HY-03-100 M.D. Anderson Hysterectomy Clamp, Curved, 25.5cm (10")

HY-03-110 M.D. Anderson Hysterectomy Clamp, Curved, 28cm (11")

 **HY-03-140** M.D. Anderson Hysterectomy Clamp, Curved, 35.5cm (14")

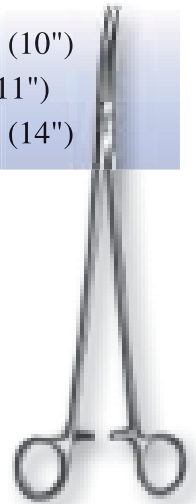

HY-13-120 Heaney Hysterectomy Forceps, Straight, Single Groove, 30.5cm (12")

HY-14-120 Heaney Hysterectomy Forceps, Curved, Single Groove, 30.5cm (12")

HY-14-825 Heaney Hysterectomy Forceps, Curved, Single Groove, 21cm (8.25")



**FULL
SIZE**

HY-10-825 Masterson Hysterectomy Forceps, Straight, 21cm (8.25")

HY-11-825 Masterson Hysterectomy Forceps, Curved, 21cm (8.25")

HY-10-100 Masterson Hysterectomy Forceps, Straight, 25.5cm (10")

HY-11-100 Masterson Hysterectomy Forceps, Curved, 25.5cm (10")

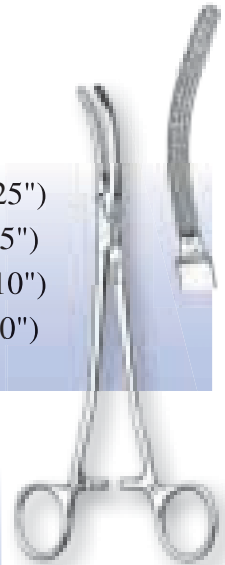

HY-16-825 Heaney-Ballentine Hysterectomy Forceps, Straight, Longitudinal Serrations, 21cm (8.25")

HY-17-825 Heaney-Ballentine Hysterectomy Forceps, Curved, Longitudinal Serrations, 21cm (8.25")



**FULL
SIZE**

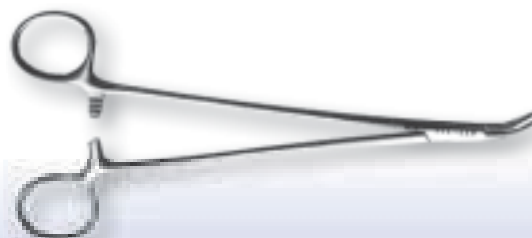

HY-19-875 Clark Clamp, Longitudinal Serrations Jaws, 22cm (8.75")

 **HY-19-120** Clark Clamp, Longitudinal Serrations Jaws, 30cm (12")

 **HY-19-140** Clark Clamp, Longitudinal Serrations Jaws, 25.5cm (14")

Hysterectomy Forceps

HY-12-825 Heaney-Rezek Hysterectomy Forceps, Straight, Single Groove, 21cm (8.25")

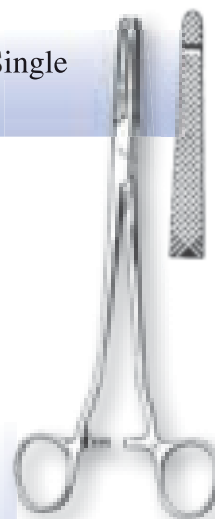

HY-04-875 Rogers Hysterectomy Forceps, Straight, 22cm (8.75")

HY-05-875 Rogers Hysterectomy Forceps, Slightly Curved, 22cm (8.75")

HY-06-875 Rogers Hysterectomy Forceps, Fully Curved, 22cm (8.75")

HY-07-875 Rogers Hysterectomy Forceps, Angled, 22cm (8.75")

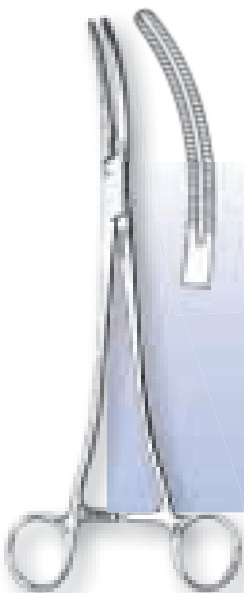

HY-08-825 Glenner Hysterectomy Forceps, Curved Left, Longitudinal Serrations, 21cm (8.25")

HY-09-825 Glenner Hysterectomy Forceps, Curved Right, Longitudinal Serrations, 21cm (8.25")



HY-01-850 Phaneuf Uterine Artery Forceps, Straight, 21.5cm (8.5")

HY-02-850 Phaneuf Uterine Artery Forceps, Angled, 21.5cm (8.5")

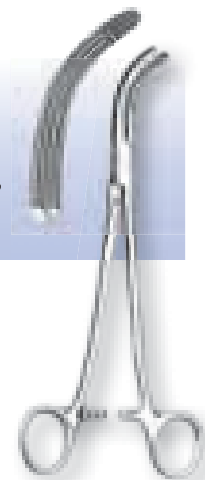

**FULL
SIZE**



Pessaries

VOLUME DISCOUNTS AVAILABLE

PP-01-000 Pessary Fitting Set, Ring Sizes 2-7



VD-01-300 Vaginal and Rectal Dilators, Silicone, Set of 4, Small Set

VD-01-400 Vaginal and Rectal Dilators, Silicone, Set of 4, Medium Set

VD-01-500 Vaginal and Rectal Dilators, Silicone, Set of 4, Large Set

PP-02-225 Mar-Land Pessary Without Support #2, 2.25"

PP-02-250 Mar-Land Pessary Without Support #3, 2.5"

PP-02-275 Mar-Land Pessary Without Support #4, 2.75"

PP-02-300 Mar-Land Pessary Without Support #5, 3"

PP-02-325 Mar-Land Pessary Without Support #6, 3.25"

PP-02-350 Mar-Land Pessary Without Support #7, 3.5"

PP-02-375 Mar-Land Pessary Without Support #8, 3.75"

PP-03-225 Mar-Land Pessary With Support #2, 2.25"

PP-03-250 Mar-Land Pessary With Support #3, 2.5"

PP-03-275 Mar-Land Pessary With Support #4, 2.75"

PP-03-300 Mar-Land Pessary With Support #5, 3"

PP-03-325 Mar-Land Pessary With Support #6, 3.25"

PP-03-350 Mar-Land Pessary With Support #7, 3.5"

PP-03-375 Mar-Land Pessary With Support #8, 3.75"



Pessaries

- PP-04-050** Dish Pessary Without Support #0, 50mm
- PP-04-055** Dish Pessary Without Support #1, 55mm
- PP-04-060** Dish Pessary Without Support #2, 60mm
- PP-04-065** Dish Pessary Without Support #3, 65mm
- PP-04-070** Dish Pessary Without Support #4, 70mm
- PP-04-075** Dish Pessary Without Support #5, 75mm
- PP-04-080** Dish Pessary Without Support #6, 80mm
- PP-04-085** Dish Pessary Without Support #7, 85mm

- PP-05-050** Dish Pessary With Support #0, 50mm
- PP-05-055** Dish Pessary With Support #1, 55mm
- PP-05-060** Dish Pessary With Support #2, 60mm
- PP-05-065** Dish Pessary With Support #3, 65mm
- PP-05-070** Dish Pessary With Support #4, 70mm
- PP-05-075** Dish Pessary With Support #5, 75mm
- PP-05-080** Dish Pessary With Support #6, 80mm
- PP-05-085** Dish Pessary With Support #7, 85mm



- PP-06-200** Oval Pessary With Support #1, 2"
- PP-06-225** Oval Pessary With Support #2, 2.25"
- PP-06-250** Oval Pessary With Support #3, 2.5"
- PP-06-275** Oval Pessary With Support #4, 2.75"
- PP-06-300** Oval Pessary With Support #5, 3"
- PP-06-325** Oval Pessary With Support #6, 3.25"
- PP-06-350** Oval Pessary With Support #7, 3.5"
- PP-06-375** Oval Pessary With Support #8, 3.75"
- PP-06-400** Oval Pessary With Support #9, 4"

Pessaries

- PP-07-200** Donut Pessary #0, 2"
- PP-07-225** Donut Pessary #1, 2.25"
- PP-07-250** Donut Pessary #2, 2.5"
- PP-07-275** Donut Pessary #3, 2.75"
- PP-07-300** Donut Pessary #4, 3"
- PP-07-325** Donut Pessary #5, 3.25"
- PP-07-350** Donut Pessary #6, 3.5"



- PP-08-150** Gellhorn Pessary #0, 1.5"
- PP-08-175** Gellhorn Pessary #1, 1.75"
- PP-08-200** Gellhorn Pessary #2, 2"
- PP-08-225** Gellhorn Pessary #3, 2.25"
- PP-08-250** Gellhorn Pessary #4, 2.5"
- PP-08-275** Gellhorn Pessary #5, 2.75"
- PP-08-300** Gellhorn Pessary #6, 3"
- PP-08-325** Gellhorn Pessary #7, 3.25"
- PP-08-350** Gellhorn Pessary #8, 3.5"

Pessaries

- PP-09-150** Shatz Pessary #0, 1.5"
- PP-09-175** Shatz Pessary #1, 1.75"
- PP-09-200** Shatz Pessary #2, 2"
- PP-09-225** Shatz Pessary #3, 2.25"
- PP-09-250** Shatz Pessary #4, 2.5"
- PP-09-275** Shatz Pessary #5, 2.75"
- PP-09-300** Shatz Pessary #6, 3"
- PP-09-325** Shatz Pessary #7, 3.25"
- PP-09-350** Shatz Pessary #8, 3.5"



- PP-10-200** Ring Pessary Without Support #1, 2"
- PP-10-225** Ring Pessary Without Support #2, 2.25"
- PP-10-250** Ring Pessary Without Support #3, 2.5"
- PP-10-275** Ring Pessary Without Support #4, 2.75"
- PP-10-300** Ring Pessary Without Support #5, 3"
- PP-10-325** Ring Pessary Without Support #6, 3.25"
- PP-10-350** Ring Pessary Without Support #7, 3.5"
- PP-10-375** Ring Pessary Without Support #8, 3.75"
- PP-10-400** Ring Pessary Without Support #9, 4"



- PP-11-200** Ring Pessary With Support #1, 2"
- PP-11-225** Ring Pessary With Support #2, 2.25"
- PP-11-250** Ring Pessary With Support #3, 2.5"
- PP-11-275** Ring Pessary With Support #4, 2.75"
- PP-11-300** Ring Pessary With Support #5, 3"
- PP-11-325** Ring Pessary With Support #6, 3.25"
- PP-11-350** Ring Pessary With Support #7, 3.5"
- PP-11-375** Ring Pessary With Support #8, 3.75"
- PP-11-400** Ring Pessary With Support #9, 4"

Pessaries

- PP-12-050** Gehrung Pessary #0, 50mm
- PP-12-055** Gehrung Pessary #1, 55mm
- PP-12-060** Gehrung Pessary #2, 60mm
- PP-12-065** Gehrung Pessary #3, 65mm
- PP-12-070** Gehrung Pessary #4, 70mm
- PP-12-075** Gehrung Pessary #5, 75mm
- PP-12-080** Gehrung Pessary #6, 80mm
- PP-12-085** Gehrung Pessary #7, 85mm
- PP-12-090** Gehrung Pessary #8, 90mm



- PP-13-065** Hodge Pessary Without Support #0. 65mm
- PP-13-070** Hodge Pessary Without Support #1. 70mm
- PP-13-075** Hodge Pessary Without Support #2. 75mm
- PP-13-080** Hodge Pessary Without Support #3. 80mm
- PP-13-085** Hodge Pessary Without Support #4. 85mm
- PP-13-090** Hodge Pessary Without Support #5. 90mm
- PP-13-095** Hodge Pessary Without Support #6. 95mm
- PP-13-100** Hodge Pessary Without Support #7. 100mm
- PP-13-105** Hodge Pessary Without Support #8. 105mm
- PP-13-110** Hodge Pessary Without Support #9. 110mm



- PP-14-065** Hodge Pessary With Support #0. 65mm
- PP-14-070** Hodge Pessary With Support #1. 70mm
- PP-14-075** Hodge Pessary With Support #2. 75mm
- PP-14-080** Hodge Pessary With Support #3. 80mm
- PP-14-085** Hodge Pessary With Support #4. 85mm
- PP-14-090** Hodge Pessary With Support #5. 90mm
- PP-14-095** Hodge Pessary With Support #6. 95mm
- PP-14-100** Hodge Pessary With Support #7. 100mm
- PP-14-105** Hodge Pessary With Support #8. 105mm
- PP-14-110** Hodge Pessary With Support #9. 110mm

Pessaries

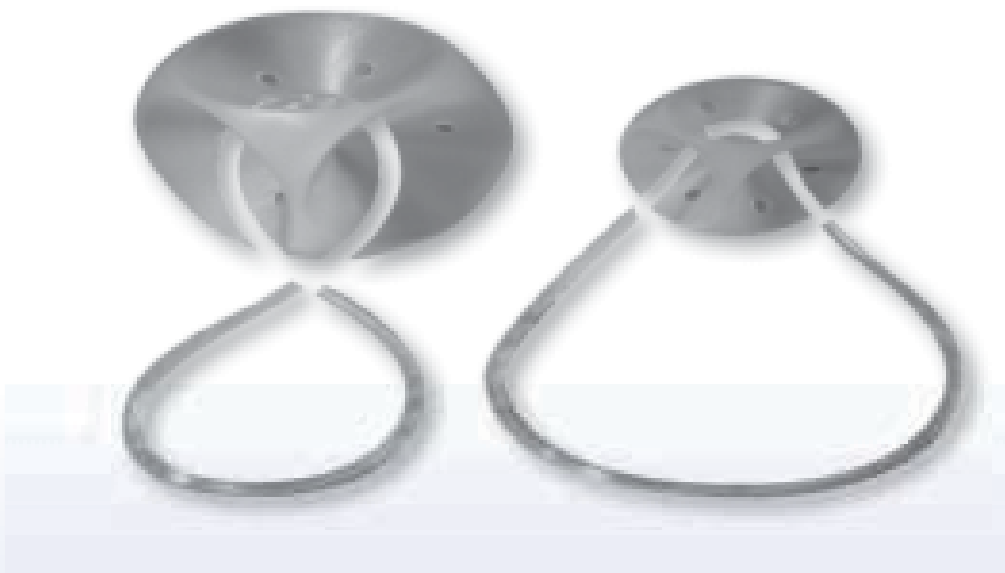

- PP-15-025** Cube Pessary Without Drains #0, 25mm
PP-15-029 Cube Pessary Without Drains #1, 29mm
PP-15-033 Cube Pessary Without Drains #2, 33mm
PP-15-037 Cube Pessary Without Drains #3, 37mm
PP-15-041 Cube Pessary Without Drains #4, 41mm
PP-15-045 Cube Pessary Without Drains #5, 45mm
PP-15-050 Cube Pessary Without Drains #6, 50mm
PP-15-056 Cube Pessary Without Drains #7, 56mm
PP-15-063 Cube Pessary Without Drains #8, 63mm
PP-15-070 Cube Pessary Without Drains #9, 70mm
PP-15-075 Cube Pessary Without Drains #10, 75mm

- PP-16-025** Cube Pessary With Drains #0, 25mm
PP-16-029 Cube Pessary With Drains #1, 29mm
PP-16-033 Cube Pessary With Drains #2, 33mm
PP-16-037 Cube Pessary With Drains #3, 37mm
PP-16-041 Cube Pessary With Drains #4, 41mm
PP-16-045 Cube Pessary With Drains #5, 45mm
PP-16-050 Cube Pessary With Drains #6, 50mm
PP-16-056 Cube Pessary With Drains #7, 56mm
PP-16-063 Cube Pessary With Drains #8, 63mm
PP-16-070 Cube Pessary With Drains #9, 70mm
PP-16-075 Cube Pessary With Drains #10, 75mm

Cannulae

- IC-01-100** Kahn Uterine Trigger Cannula, 25.5cm (10")
- IC-02-100** Short Flexible Cannula Tip, Teflon, Pack of 3
- IC-03-100** Flexible Cannula Tip, Teflon, Pack of 3
- IC-04-100** Cannula Acorn, Rubber, Pack of 3
- IC-06-100** Cannula Acorn, Teflon, Single Unit
- IC-10-100** Collar and Screw, with Rubber Gasket

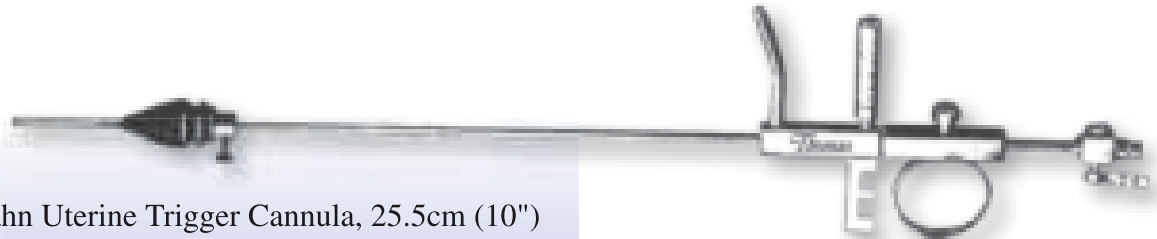

- IC-11-100** Jarco Self-Retaining Cannula, 25.5cm (10")



Ligature Carriers

- LC-01-800** Miya Hook, 20cm (8")

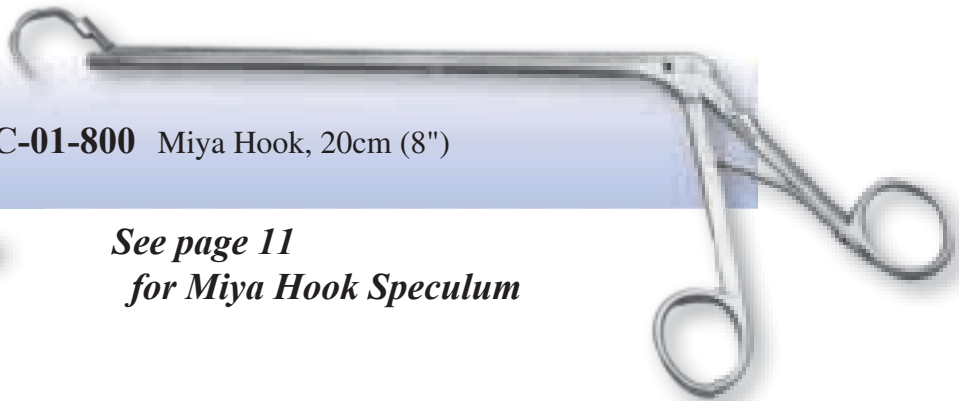

*See page 11
for Miya Hook Speculum*

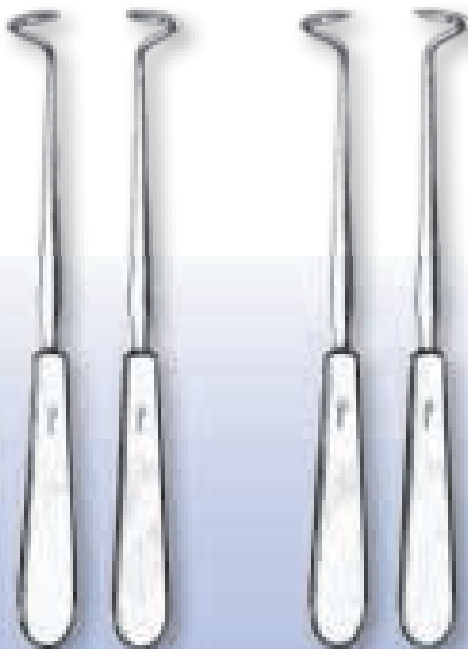



- LC-04-800** Deschamp Ligature Carrier, Blunt, Curved Right, 20cm (8")
- LC-05-800** Deschamp Ligature Carrier, Blunt, Curved Left, 20cm (8")
- LC-06-800** Deschamp Ligature Carrier, Sharp, Curved Right, 20cm (8")
- LC-07-800** Deschamp Ligature Carrier, Sharp, Curved Left, 20cm (8")

Instestinal Instrumentation



- II-01-500** Allis Forceps, 3x4 Teeth, 13cm (5")
- II-01-550** Allis Forceps, 3x4 Teeth, 14cm (5.5")
- II-02-550** Allis Forceps, 4x5 Teeth, 14cm (5.5")
- II-02-600** Allis Forceps, 4x5 Teeth, 15cm (6")
- II-03-600** Allis Forceps, 5x6 Teeth, 15cm (6")
- II-03-750** Allis Forceps, 5x6 Teeth, 19cm (7.5")
- II-03-900** Allis Forceps, 5x6 Teeth, 23cm (9")
- II-03-100** Allis Forceps, 5x6 Teeth, 25.5cm (10")
-  **II-03-120** Allis Forceps, 5x6 Teeth, 30cm (12")
- II-03-140** Allis Forceps, 5x6 Teeth, 35.5cm (14")



- II-04-525** Babcock Forceps, Baby, 13.5cm (5.25")
- II-04-625** Babcock Forceps, Baby, 16cm (6.25")
- II-05-650** Babcock Forceps, 16.5cm (6.5")
- II-05-725** Babcock Forceps, 18.5cm (7.25")
- II-05-800** Babcock Forceps, 20cm (8")
- II-05-950** Babcock Forceps, 24cm (9.5")
-  **II-05-120** Babcock Forceps, 30cm (12")
-  **II-05-140** Babcock Forceps, 35.5cm (14")

Circumcision Clamps

- CV-01-000** Mogen Circumcision Clamp, Adult
- CV-01-100** Mogen Circumcision Clamp, Infant/Child

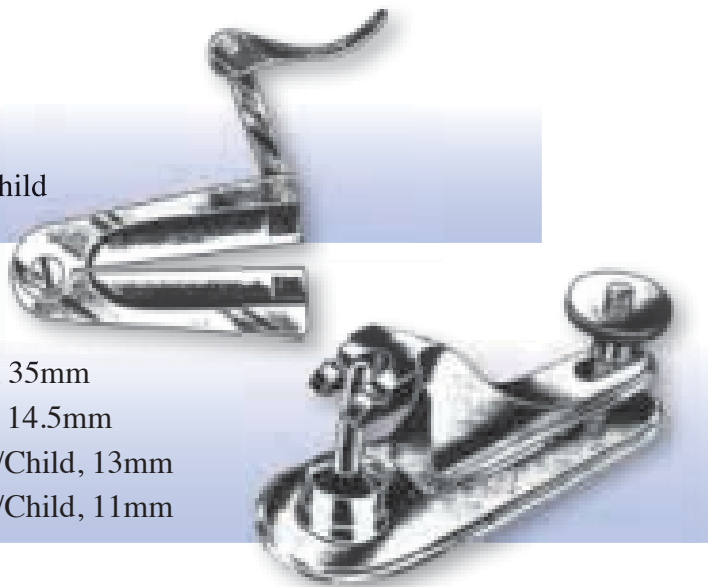

- CV-02-035** GOMCO[™] Circumcision Clamp, Adult, 35mm
- CV-02-145** GOMCO[™] Circumcision Clamp, Child, 14.5mm
- CV-02-130** GOMCO[™] Circumcision Clamp, Infant/Child, 13mm
- CV-02-110** GOMCO[™] Circumcision Clamp, Infant/Child, 11mm

Corson Myoma Grasping Forceps



- CF-04-007** Corson Myoma Grasping Forceps, 7mm Jaws; 33cm (13")
- CF-04-011** Corson Myoma Grasping Forceps, 11mm Jaws; 33cm (13")
- CF-04-017** Corson Myoma Grasping Forceps, 17mm Jaws; 33cm (13")

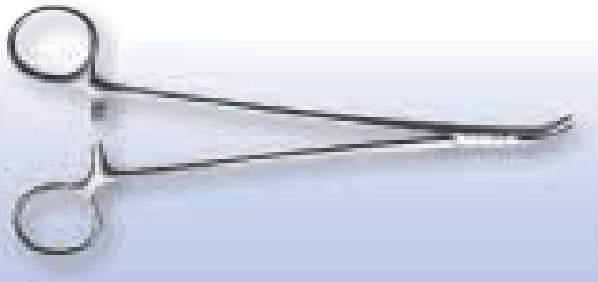

Miscellaneous OB/GYN Instruments

- MG-04-105** Collin Uterine Clamp; 26.5cm (10.5")



- MG-05-875** Clark Artery Forceps, Side Curved, Longitudinal Serrations; 22cm (8.75")
-  **MG-06-120** Clark Artery Forceps, Side Curved, Longitudinal Serrations; 30cm (12")
-  **MG-06-140** Clark Artery Forceps, Side Curved, Longitudinal Serrations; 35.5cm (14")

- MG-07-950** Hulka Uterine Mobilizer/Tenaculum; 24cm (9.5")
- MG-08-950** Hulka Uterine Mobilizer/Tenaculum, with Acorn Tip; 24cm (9.5")
- MG-10-950** Hulka Uterine Mobilizer/Tenaculum, Atraumatic; 24cm (9.5")

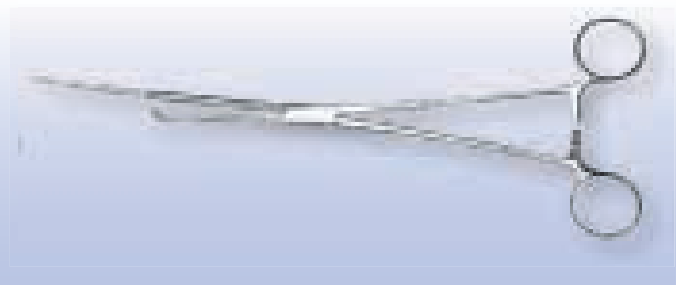

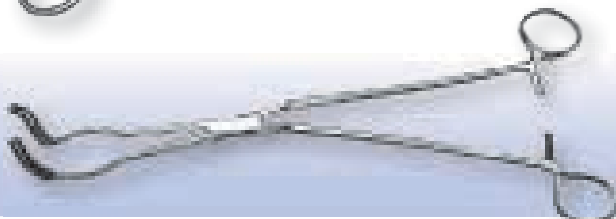

- MG-09-100** Buxton Uterine Clamp; 25cm (10")



- MG-15-950** Siegler-Hellman Clamp; 24cm (9.5")

Not Pictured:

-  **YS-01-120** Yankauer Suction Tube, 30cm (12")
-  **YS-01-140** Yankauer Suction Tube, 35.5cm (14")

LLETZ/LEEP Loop Electrodes

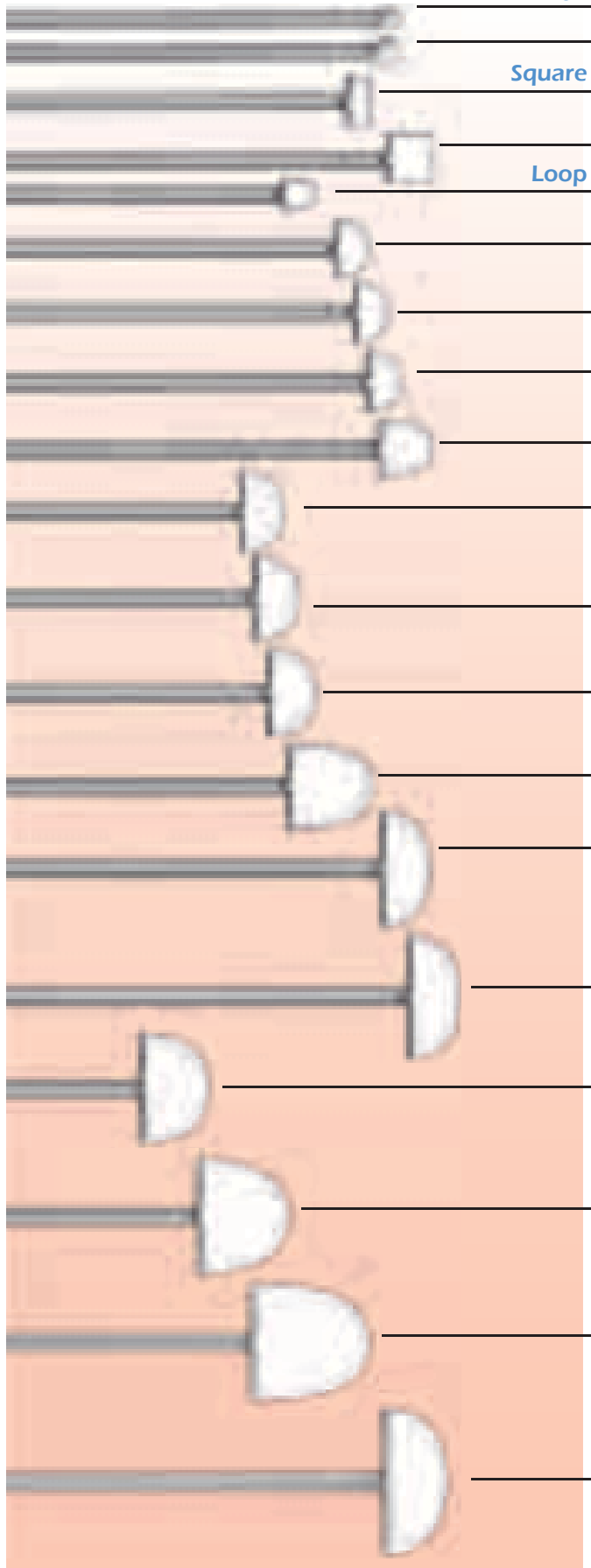

- LE-13-003** 3mm, Shaft: 13cm (5")
- LE-14-005** 5mm, Shaft: 13cm (5")
- LE-29-505** 5mm x 5mm, Square, Shaft: 13cm (5")
- LE-06-101** 10mm x 10mm, Square, Shaft: 13cm (5")
- LE-06-108** 10mm x 8mm, Square, Shaft: 13cm (5")
- LE-03-505** 5mm x 5mm, Shaft: 13cm (5")
- LE-04-105** 10mm x 5mm, Shaft: 13cm (5")
- LE-22-107** 10mm x 7mm, Shaft: 13cm (5")
- LE-28-108** 10mm x 8mm, Shaft: 13cm (5")
- LE-05-101** 10mm x 10mm, Shaft: 13cm (5")
- LE-23-155** 15mm x 5mm, Shaft: 13cm (5")
- LE-27-157** 15mm x 7mm, Shaft: 13cm (5")
- LE-07-158** 15mm x 8mm, Shaft: 13cm (5")
- LE-08-151** 15mm x 15mm, Shaft: 13cm (5")
- LE-08-153** 15mm x 13mm, Shaft: 13cm (5")
- LE-09-208** 20mm x 8mm, Shaft: 13cm (5")
- LE-24-201** 20mm x 10mm, Shaft: 13cm (5")
- LE-28-212** 20mm x 12mm, Shaft: 13cm (5")
- LE-10-203** 20mm x 13mm, Shaft: 13cm (5")
- LE-11-205** 20mm x 15mm, Shaft: 13cm (5")
- LE-25-202** 20mm x 20mm, Shaft: 13cm (5")
- LE-12-251** 25mm x 10mm, Shaft: 13cm (5")
- LE-26-150** 15mm x 10mm, Shaft: 13cm (5")

Sterile, Disposable, Each Sold as a Box of 5

LLETZ/LEEP

- LQ-02-012** Conductive Adhesive Electrode Pads, Disposable, Adult; Box of 12
- LQ-03-025** Conductive Adhesive Electrode Pads, Disposable for ZSI ESU; Box of 25
- LQ-04-025** Conductive Adhesive Electrode Pads, Dual Dispersive Disposable; Box of 25
- LQ-39-025** Conductive Electrode Pads With Cable, Disposable, Cooper; Box of 25
- LQ-40-050** Conductive Electrode Pads Without Cable, Disposable; Box of 50
For Cooper 1000 and 6000 ESU
- LQ-05-020** Hand Switching Pencil and Cord, Disposable; Box of 20
- LQ-09-020** Foot Control Handle and Cord #950, Disposable; Box of 20 For Cooper
- LQ-20-300** Smoke Evacuator Filters for MiniVac; Case of 3
- LQ-21-375** Smoke Evacuation Tubing Assembly; Corrugated Tubing, Reducer,
3/8" Tubing, Box of 3, Assemblies
- LQ-22-006** Smoke Evacuator Tubing, 3/8" Diameter, Case of 6, 61cm (24")
- LQ-23-100** Smoke Evacuator Accessory Kit, 1 Filter and 1 Tubing Assembly
- LQ-26-500** DSE Tubing, Box of 50
- LQ-31-012** Monsel's Solution, 8ml, with Applicator, Package of 12
- LQ-32-012** Lugol's Iodine Solution, 5ml Doses, Package of 12
- LQ-38-101** Versa Vac Smoke Evacuator Filter
- LQ-34-078** Corrigated Tubing, 7/8" x 6'
- LQ-36-010** Reducer for Smoke Evacuator, Disposable, Single Patient Use,
Connects Pre-Filter to Patient Tubing Set, 3/8", Box of 10
- LQ-36-100** Pre-Filter for Smoke Evacuator Replacement Filter for Cooper System 6080, Box of 10
- LQ-35-001** Reducer for Smoke Evacuator, Connects Pre-Filter (LQ-36-100) to
Corrigated Tubing and "s" Tubing
- LQ-33-010** Patient Tubing Set, 6' Disposable Tubing with DSE Tube, 10 Sets per Box

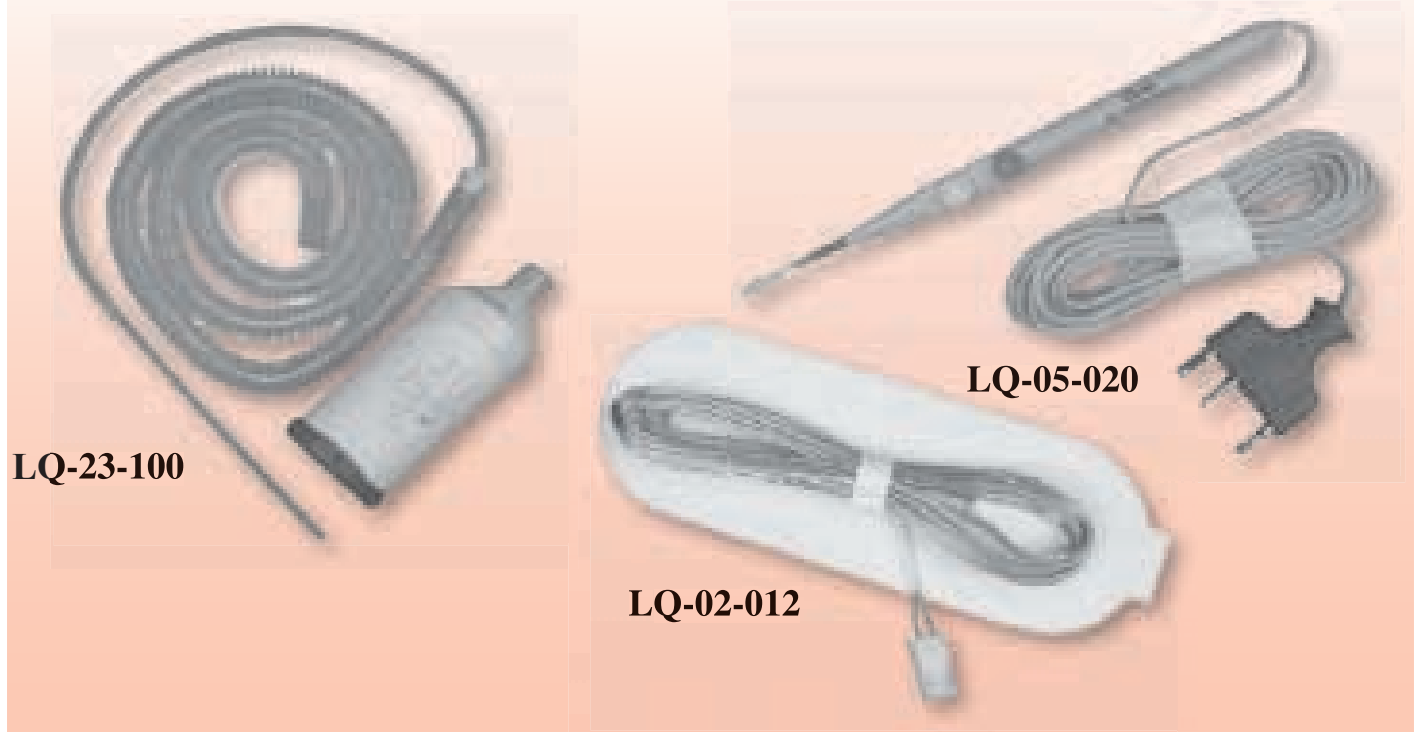

LLETZ/LEEP Instrumentation

- LL-33-700** Graves NonConductive Speculum, XL, 1 Smoke Tube; Size: 7" Long Blades
- LL-33-600** Graves NonConductive Speculum, Supersize, 1 Smoke Tube; Size: 6" Long Blades
- LL-33-475** Graves NonConductive Speculum, Large, 1 Smoke Tube; 12cm x 4cm (4.75" x 1.5")
- LL-33-400** Graves NonConductive Speculum, Medium, 1 Smoke Tube; 10cm x 4cm (4" x 1.5")
- LL-33-300** Graves NonConductive Speculum, Small, 1 Smoke Tube; 7.5cm x 2cm (3" x 3/4")
- LL-34-700** Pederson NonConductive Speculum, XL, 1 Smoke Tube; Size: 7" Long Blades
- LL-34-600** Pederson NonConductive Speculum, Supersize, 1 Smoke Tube; Size: 6" Long Blades
- LL-34-450** Pederson NonConductive Speculum, Large, 1 Smoke Tube; 11.5cm x 2.5cm (4.5" x 1")
- LL-34-400** Pederson NonConductive Speculum, Medium, 1 Smoke Tube; 10cm x 2.5cm (4" x 1")
- LL-34-300** Pederson NonConductive Speculum, Small, 1 Smoke Tube; 7.5cm x 1.5cm (3" x 1/2")
- LL-35-450** Pederson NonConductive Speculum, Extra Narrow, 1 Smoke Tube; 11.5cm x 1.5cm (4.5" x 9/16")
- LL-35-700** Redundant Wall NonConductive Reactor, 9cm x 2cm (3.5" x .75") Blades; 18cm (7")
- LL-36-110** Kogan NonConductive Endocervical Speculum, Standard Tips; 28cm (11")
- LL-37-110** Kogan NonConductive Endocervical Speculum, Narrow Tips; 28cm (11")
- LL-38-425** Collin NonConductive Speculum, Large, 1 Smoke Tube; 11cm x 4cm (4.25" x 1.5")
- LL-38-400** Collin NonConductive Speculum, Medium, 1 Smoke Tube; 10cm x 3.5cm (4" x 1.5")
- LL-39-900** Emmett NonConductive Hook, Fully Curved, Round Handle; 23cm (9")
- LL-40-900** Emmett NonConductive Hook, Angled, Round Handle; 23cm (9")
- LL-41-900** Iris NonConductive Hook; 23cm (9")
- LL-42-110** Measuring NonConductive Ruler, Vertical; 28.5cm (11.25")
- LL-43-110** Measuring NonConductive Ruler, Lateral; 27cm (10.75")
- LL-44-100** Schroeder NonConductive Tenaculum, Exposed Tips; 25cm (10")
- LL-45-100** Schroeder NonConductive Tenaculum, Coated Tips; 25cm (10")

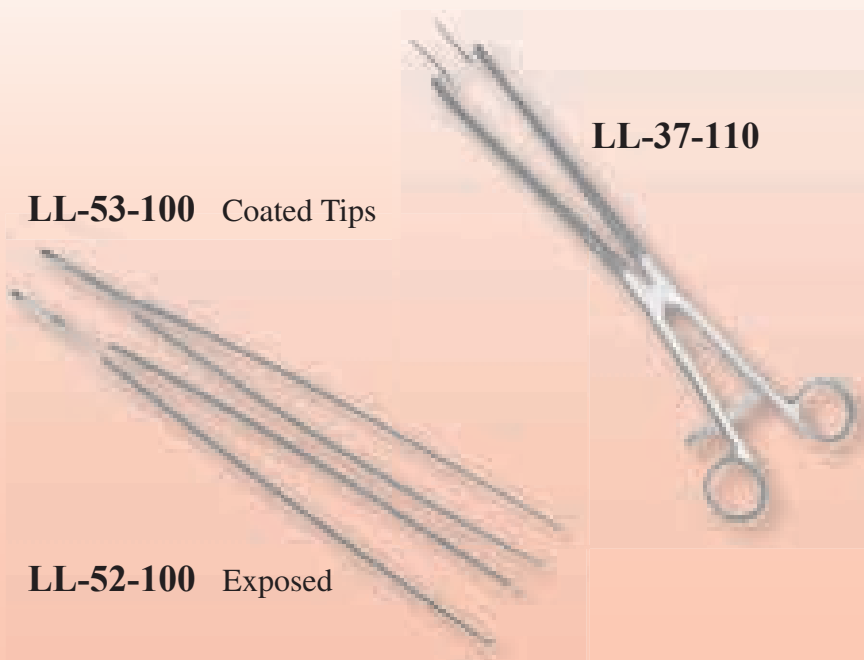
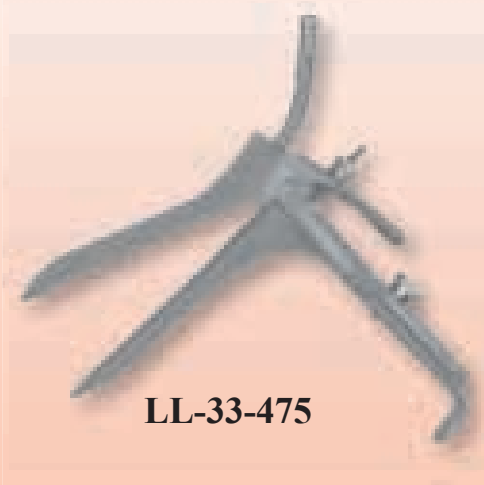





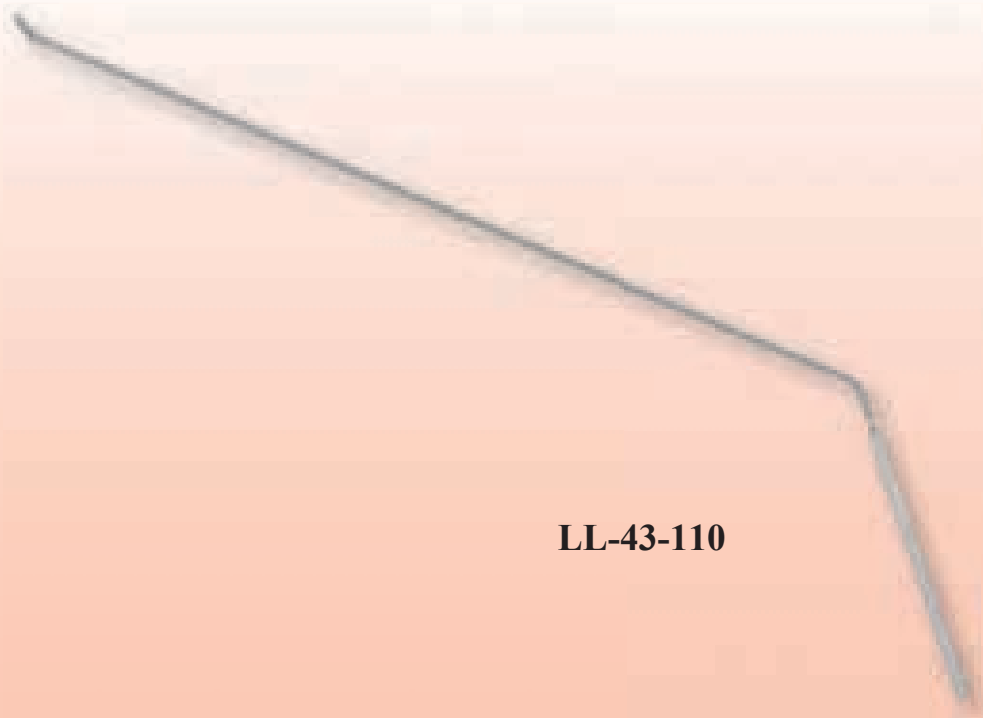



LLETZ/LEEP Instrumentation

- LL-46-800** Dressing NonConductive Forceps, Exposed Tips; 20cm (8")
- LL-47-800** Dressing NonConductive Forceps, Coated Tips; 20cm (8")
- LL-48-800** Tissue NonConductive Forceps, 1x2 Teeth, Exposed Tips; 20cm (8")
- LL-49-800** Tissue NonConductive Forceps, 1x2 Teeth, Coated Tips; 20cm (8")
- LL-50-100** Dressing NonConductive Forceps, Exposed Tips; 25.5cm (10")
- LL-51-100** Dressing NonConductive Forceps, Coated Tips; 25.5cm (10")
- LL-52-100** Tissue NonConductive Forceps, 1x2 Teeth, Exposed Tips; 25.5cm (10")
- LL-53-100** Tissue NonConductive Forceps, 1x2 Teeth, Coated Tips; 25.5cm (10")
- LL-54-475** Weisman-Graves NonConductive Speculum, Left Opening, Large, 1 Smoke Tube; 12cm x 4cm (4.75" x 1.5")
- LL-54-400** Weisman-Graves NonConductive Speculum, Left Opening, Medium, 1 Smoke Tube; 10cm x 4cm (4" x 1.5")
- LL-55-475** Weisman-Graves NonConductive Speculum, Right Opening, Large, 1 Smoke Tube; 12cm x 4cm (4.75" x 1.5")
- LL-55-400** Weisman-Graves NonConductive Speculum, Right Opening, Medium, 1 Smoke Tube; 10cm x 4cm (4" x 1.5")
- LL-56-450** ZED-More NonConductive Speculum, Large, 1 Smoke Tube; 12cm x 4cm (4.5" x 1.5")
- LL-56-500** ZED-More NonConductive Speculum, Extra Large, 1 Smoke Tube; 12cm x 4cm (4.5" x 1.5")
- LL-56-400** ZED-More NonConductive Speculum, Medium, 1 Smoke Tube; 10cm x 4cm (4" x 1.5")
- LL-57-950** NonConductive Ring Forceps; Length: 24cm (9.5")
- LL-58-300** Lateral Wall Retractor, Non-Conductive, Blade 3"
- LL-58-450** Lateral Wall Retractor, Non-Conductive, Blade 4.5"



LL-43-110

ZED Scissors

- ZS-01-900** ZED-Scissors, Slightly Curved, Tungsten Carbide Inserts; 23cm (9")
- ZS-01-105** ZED-Scissors, Slightly Curved, Tungsten Carbide Inserts; 26.5cm (10.5")
-  ZS-01-120** ZED-Scissors, Slightly Curved, Tungsten Carbide Inserts; 30.5cm (12")
-  ZS-01-140** ZED-Scissors, Slightly Curved, Tungsten Carbide Inserts; 35.5cm (14")
- ZS-02-900** ZED-Scissors, Curved, Tungsten Carbide Inserts; 23cm (9")
- ZS-02-105** ZED-Scissors, Curved, Tungsten Carbide Inserts; 26.5cm (10.5")
-  ZS-02-120** ZED-Scissors, Curved, Tungsten Carbide Inserts; 30.5cm (12")
-  ZS-02-140** ZED-Scissors, Curved, Tungsten Carbide Inserts; 35cm (14")
- ZS-03-900** ZED-Scissors, Fully Curved, Tungsten Carbide Inserts; 23cm (9")
- ZS-03-105** ZED-Scissors, Fully Curved, Tungsten Carbide Inserts; 26.5cm (10.5")
-  ZS-03-120** ZED-Scissors, Fully Curved, Tungsten Carbide Inserts; 30.5cm (12")
-  ZS-03-140** ZED-Scissors, Fully Curved, Tungsten Carbide Inserts; 35cm (14")
- ZS-04-900** ZED-Scissors, Straight, Tungsten Carbide Inserts; 23cm (9")
- ZS-04-105** ZED-Scissors, Straight, Tungsten Carbide Inserts; 26.5cm (10.5")
-  ZS-04-120** ZED-Scissors, Straight, Tungsten Carbide Inserts; 30.5cm (12")
-  ZS-04-140** ZED-Scissors, Straight, Tungsten Carbide Inserts; 35.5cm (14")
- ZS-15-900** Radiance ZED-Scissors, Slightly Curved, Tungsten Carbide Inserts; 23cm (9")
- ZS-16-900** Radiance ZED-Scissors, Curved, Tungsten Carbide Inserts; 23cm (9")
- ZS-17-900** Radiance ZED-Scissors, Fully Curved, Tungsten Carbide Inserts; 23cm (9")

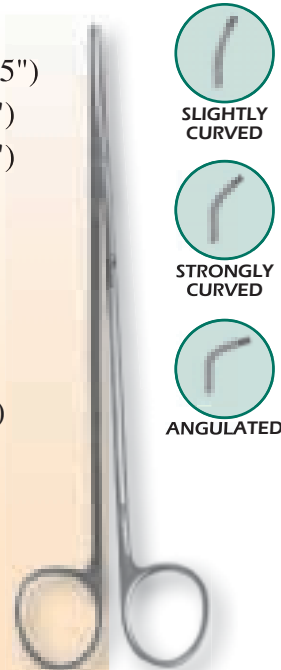

Also see page 29 for matching hysterectomy clamps

OB/GYN Scissors

- GS-03-625** Joseph Uterine Scissors, Straight; 16cm (6.25")
- GS-04-625** Joseph Uterine Scissors, Curved; 16cm (6.25")



- GS-05-700** Kelly Uterine Scissors, Straight; 18cm (7")
- GS-06-700** Kelly Uterine Scissors, Curved; 18cm (7")



- GS-01-800** Sims Uterine Scissors, Straight; 20cm (8")
- GS-02-800** Sims Uterine Scissors, Curved; 20cm (8")



- GS-07-975** Satinsky Scissors, S-Curved; 25cm (9.75")



 For Plus Size Patients

OB/GYN Scissors

GS-08-100 Willauer Scissors, Straight; 25.5cm (10")

GS-09-100 Willauer Scissors, Curved; 25.5cm (10")



GS-10-875 Jorgensen Thoracic Scissors, Curved; 22cm (8.75")



GS-11-110 Finochietto Scissors, Angled On Flat; 27cm (10.75")



GS-12-120 Crafoord Cardiovascular Scissors, Curved; 30.5cm (12")



GS-13-750 Thorek Preparation Scissors, Fully Curved; 19cm (7.5")

GS-13-100 Thorek Preparation Scissors, Fully Curved; 25.5cm (10")



GS-14-650 Busch Umbilical Scissors; 16cm (6.5")



GS-15-575 Braun Episiotomy Scissors; 14.5cm (5.75")

GS-15-875 Braun Episiotomy Scissors; 22cm (8.75")



GS-16-450 USA Umbilical Scissors; 10.5cm (4.5")

GS-17-100 Siebold Uterine Scissors, S-Curved; 25cm (10")



Not Pictured:

GS-18-105 Dubois Scissors, Curved, Blunt / Blunt; Length 26cm (10.5")

Operating Scissors



- OP-01-500** Operating Scissors, Straight, Blunt/Blunt; 13cm (5")
- OP-01-575** Operating Scissors, Straight, Blunt/Blunt; 14.5cm (5.75")
- OP-01-650** Operating Scissors, Straight, Blunt/Blunt; 16.5cm (6.5")
- OP-02-450** Operating Scissors, Straight, Blunt/Sharp; 11.5cm (4.5")
- OP-02-500** Operating Scissors, Straight, Blunt/Sharp; 13cm (5")
- OP-02-575** Operating Scissors, Straight, Blunt/Sharp; 14.5cm (5.75")
- OP-02-600** Operating Scissors, Straight, Blunt/Sharp; 15.5cm (6")
- OP-02-650** Operating Scissors, Straight, Blunt/Sharp; 16.5cm (6.5")
- OP-02-725** Operating Scissors, Straight, Blunt/Sharp; 18.5cm (7.25")
- OP-02-800** Operating Scissors, Straight, Blunt/Sharp; 20cm (8")
- OP-03-500** Operating Scissors, Straight, Sharp/Sharp; 13cm (5")
- OP-03-575** Operating Scissors, Straight, Sharp/Sharp; 14.5cm (5.75")
- OP-03-650** Operating Scissors, Straight, Sharp/Sharp; 16.5cm (6.5")
- OP-04-500** Operating Scissors, Curved, Blunt/Blunt; 13cm (5")
- OP-04-575** Operating Scissors, Curved, Blunt/Blunt; 14.5cm (5.75")
- OP-04-650** Operating Scissors, Curved, Blunt/Blunt; 16.5cm (6.5")
- OP-05-450** Operating Scissors, Curved, Blunt/Sharp; 11.5cm (4.5")
- OP-05-500** Operating Scissors, Curved, Blunt/Sharp; 13cm (5")
- OP-05-575** Operating Scissors, Curved, Blunt/Sharp; 14.5cm (5.75")
- OP-05-600** Operating Scissors, Curved, Blunt/Sharp; 15.5cm (6")
- OP-05-650** Operating Scissors, Curved, Blunt/Sharp; 16.5cm (6.5")
- OP-05-725** Operating Scissors, Curved, Blunt/Sharp; 18.5cm (7.25")
- OP-05-800** Operating Scissors, Curved, Blunt/Sharp; 20cm (8")
- OP-06-500** Operating Scissors, Curved, Sharp/Sharp; 13cm (5")
- OP-06-575** Operating Scissors, Curved, Sharp/Sharp; 14.5cm (5.75")
- OP-06-600** Operating Scissors, Curved, Sharp/Sharp; 16.5cm (6.5")

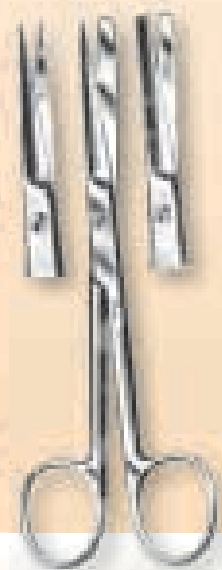

- OP-07-550** Deaver Operating Scissors, Straight, Blunt/Blunt; 14cm (5.5")
- OP-07-600** Deaver Operating Scissors, Curved, Blunt/Blunt; 14cm (5.5")
- OP-07-650** Deaver Operating Scissors, Straight, Blunt/Sharp; 14cm (5.5")
- OP-07-700** Deaver Operating Scissors, Curved, Blunt/Sharp; 14cm (5.5")
- OP-07-750** Deaver Operating Scissors, Straight, Sharp/Sharp; 14cm (5.5")
- OP-07-800** Deaver Operating Scissors, Curved, Sharp/Sharp; 14cm (5")



- OP-16-575** Mayo Scissors, Straight, Tungsten Carbide inserts; 14.5cm (5.75")
- OP-16-675** Mayo Scissors, Straight, Tungsten Carbide inserts; 17cm (6.75")
- OP-16-900** Mayo Scissors, Straight, Tungsten Carbide inserts; 23cm (9")
- OP-17-575** Mayo Scissors, Curved, Tungsten Carbide inserts; 14.5cm (5.75")
- OP-17-675** Mayo Scissors, Curved, Tungsten Carbide inserts; 17cm (6.75")
- OP-17-900** Mayo Scissors, Curved, Tungsten Carbide inserts; 23cm (9")

Operating Scissors

- OP-09-550** Mayo Dissecting Scissors, Straight; 14cm (5")
- OP-09-675** Mayo Dissecting Scissors, Straight; 17cm (6.75")
- OP-09-900** Mayo Dissecting Scissors, Straight; 23cm (9")
- OP-09-110** Mayo Dissecting Scissors, Straight; 28cm (11")
- OP-10-550** Mayo Dissecting Scissors, Curved; 14cm (5")
- OP-10-675** Mayo Dissecting Scissors, Curved; 17cm (6.75")
- OP-10-900** Mayo Dissecting Scissors, Curved; 23cm (9")



- OP-14-675** Mayo Noble Dissecting Scissors, Straight; 17cm (6.75")
- OP-15-675** Mayo Noble Dissecting Scissors, Curved; 17cm (6.75")

- OP-18-110** Mayo Harrington Dissecting Scissors, Curved, Tungsten Carbide Inserts; 28cm (11")
- OP-11-110** Mayo Harrington Dissecting Scissors, Curved; 28cm (11")
- OP-11-120** Mayo Harrington Dissecting Scissors, Straight; 28cm (11")

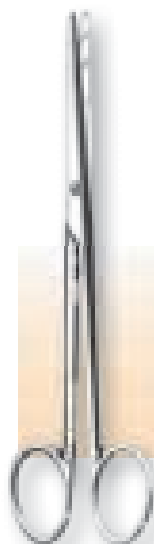





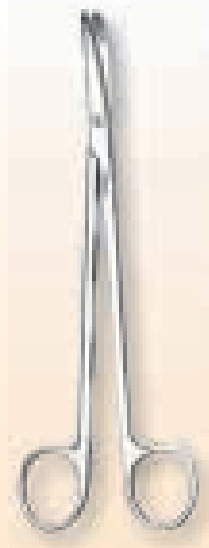

- OP-12-600** Mayo Stille Dissecting Scissors, Straight; 15cm (6")
- OP-12-675** Mayo Stille Dissecting Scissors, Straight; 17cm (6.75")
- OP-13-600** Mayo Stille Dissecting Scissors, Curved; 15cm (6")
- OP-13-675** Mayo Stille Dissecting Scissors, Curved; 17cm (6.75")

Metzenbaum Scissors

- MS-03-575** Metzenbaum Scissors, Straight, Tungsten Carbide Inserts; 14.5cm (5.75")
MS-04-575 Metzenbaum Scissors, Straight, Delicate, Tungsten Carbide Inserts; 14.5cm (5.75")
MS-03-700 Metzenbaum Scissors, Straight, Tungsten Carbide Inserts; 18cm (7")
MS-04-700 Metzenbaum Scissors, Straight, Tungsten Carbide Inserts; 18cm (7")
MS-03-800 Metzenbaum Scissors, Straight, Tungsten Carbide Inserts; 20cm (8")
MS-04-800 Metzenbaum Scissors, Straight, Delicate, Tungsten Carbide Inserts; 20cm (8")
MS-04-900 Metzenbaum Scissors, Straight, Delicate, Tungsten Carbide Inserts; 23cm (9")
MS-03-900 Metzenbaum Scissors, Straight, Tungsten Carbide Inserts; 23cm (9")
MS-05-575 Metzenbaum Scissors, Curved, Tungsten Carbide Inserts; 14.5cm (5.75")
MS-06-575 Metzenbaum Scissors, Curved, Delicate, Tungsten Carbide Inserts; 14.5cm (5.75")
MS-07-575 Metzenbaum Scissors, Curved, Sharp/Sharp, Delicate, Tungsten Carbide Inserts; 14.5cm (5.75")
MS-05-700 Metzenbaum Scissors, Curved, Tungsten Carbide Inserts; 18cm (7")
MS-06-700 Metzenbaum Scissors, Curved, Delicate, Tungsten Carbide Inserts; 18cm (7")
MS-07-700 Metzenbaum Scissors, Curved, Sharp/Sharp, Delicate, Tungsten Carbide Inserts; 18cm (7")
MS-05-800 Metzenbaum Scissors, Curved, Tungsten Carbide Inserts; 20cm (8")
MS-06-800 Metzenbaum Scissors, Curved, Delicate, Tungsten Carbide Inserts 20cm (8")
MS-07-800 Metzenbaum Scissors, Curved, Sharp/Sharp, Delicate, Tungsten Carbide Inserts; 20cm (8")
MS-05-900 Metzenbaum Scissors, Curved, Tungsten Carbide Inserts; 23cm (9")
MS-06-900 Metzenbaum Scissors, Curved, Delicate, Tungsten Carbide Inserts; 23cm (9")
MS-07-900 Metzenbaum Scissors, Curved, Sharp/Sharp, Delicate, Tungsten Carbide Inserts; 23cm (9")



- MS-01-600** Metzenbaum Dissecting Scissors, Straight; 15cm (6")
MS-01-700 Metzenbaum Dissecting Scissors, Straight; 18cm (7")
MS-01-800 Metzenbaum Dissecting Scissors, Straight; 20cm (8")
MS-01-900 Metzenbaum Dissecting Scissors, Straight; 23cm (9")
MS-01-100 Metzenbaum Dissecting Scissors, Straight; 25.5cm (10")
 **MS-01-110** Metzenbaum Dissecting Scissors, Straight; 28cm (11")
 **MS-01-120** Metzenbaum Dissecting Scissors, Straight; 30cm (12")
 **MS-01-140** Metzenbaum Dissecting Scissors, Straight; 35.5cm (14")
MS-02-600 Metzenbaum Dissecting Scissors, Curved; 15cm (6")
MS-02-700 Metzenbaum Dissecting Scissors, Curved; 18cm (7")
MS-02-800 Metzenbaum Dissecting Scissors, Curved; 20cm (8")
MS-02-900 Metzenbaum Dissecting Scissors, Curved; 23cm (9")
 **MS-02-110** Metzenbaum Dissecting Scissors, Curved; 28cm (11")
 **MS-02-120** Metzenbaum Dissecting Scissors, Curved; 30cm (12")
 **MS-02-140** Metzenbaum Dissecting Scissors, Curved; 35.5cm (14")



Small Scissors

- SS-07-450** Iris Scissors, Straight, Tungsten Carbide Inserts; 11.5cm (4.5")
- SS-08-450** Iris Scissors, Curved, Tungsten Carbide Inserts; 11.5cm (4.5")
- SS-01-350** Iris Derma Scissors, Straight, Extra Fine; 9cm (3.5")
- SS-02-350** Iris Scissors, Straight; 10cm (4")
- SS-02-450** Iris Scissors, Straight; 11.5cm (4.5")
- SS-03-350** Iris Derma Scissors, Curved, Extra Fine; 9cm (3.5")
- SS-04-350** Iris Scissors, Curved; 10cm (4")
- SS-04-450** Iris Scissors, Curved; 11.5cm (4.5")
- SS-12-350** Spencer Stitch Scissors; 9cm (3.5")
- SS-13-350** O'Brien Stitch Scissors; 10cm (4")



- SS-09-450** Strabismus Scissors, Straight, Tungsten Carbide Inserts; 11.5cm (4.5")
- SS-10-450** Strabismus Scissors, Curved, Tungsten Carbide Inserts; 11.5cm (4.5")
- SS-05-425** Strabismus Scissors, Straight; 11cm (4.25")
- SS-06-425** Strabismus Scissors, Curved; 11cm (4.25")



Bandage Scissors

- BS-01-350** Lister Bandage Scissors; 9cm (3.5")
- BS-01-425** Lister Bandage Scissors; 11cm (4.25")
- BS-01-550** Lister Bandage Scissors; 14cm (5.5")
- BS-01-700** Lister Bandage Scissors; 18cm (7")
- BS-01-800** Lister Bandage Scissors; 20cm (8")



Dressing Forceps

- DF-01-450** Dressing Forceps, Serrated; 11.5cm (4.5")
- DF-01-500** Dressing Forceps, Serrated; 13cm (5")
- DF-01-575** Dressing Forceps, Serrated; 14.5cm (5.75")
- DF-01-625** Dressing Forceps, Serrated; 16cm (6.25")
- DF-01-800** Dressing Forceps, Serrated; 20cm (8")
- +** **DF-01-100** Dressing Forceps, Serrated; 25cm (10")
- +** **DF-01-120** Dressing Forceps, Serrated; 30cm (11.75")



Tissue Forceps

- TF-01-450** Tissue Forceps, 1x2 Teeth; 11.5cm (4.5")
- TF-01-500** Tissue Forceps, 1x2 Teeth; 13cm (5")
- TF-01-575** Tissue Forceps, 1x2 Teeth; 14.5cm (5.75")
- TF-01-625** Tissue Forceps, 1x2 Teeth; 16cm (6.25")
- TF-01-675** Tissue Forceps, 1x2 Teeth; 17cm (6.75")
- TF-01-800** Tissue Forceps, 1x2 Teeth; 20cm (8")
- TF-01-100** Tissue Forceps, 1x2 Teeth; 25cm (10")
- +** **TF-01-120** Tissue Forceps, 1x2 Teeth; 30cm (11.75")
- +** **TF-01-140** Tissue Forceps, 1x2 Teeth; 35.5cm (14")

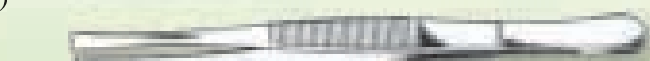
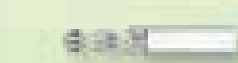
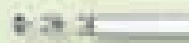

- TF-02-500** Tissue Forceps, 2x3 Teeth; 13cm (5")
- TF-02-575** Tissue Forceps, 2x3 Teeth; 14.5cm (5.75")
- TF-02-625** Tissue Forceps, 2x3 Teeth; 16cm (6.25")
- TF-02-800** Tissue Forceps, 2x3 Teeth; 20cm (8")
- TF-02-100** Tissue Forceps, 2x3 Teeth; 25cm (10")
- +** **TF-02-120** Tissue Forceps, 2x3 Teeth; 30cm (11.75")



- TF-03-500** Tissue Forceps, 3x4 Teeth; 13cm (5")
- TF-03-575** Tissue Forceps, 3x4 Teeth; 14.5cm (5.75")
- TF-03-625** Tissue Forceps, 3x4 Teeth; 16cm (6.25")
- TF-03-800** Tissue Forceps, 3x4 Teeth; 20cm (8")

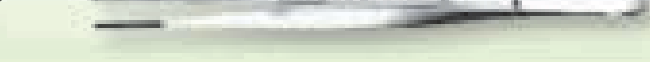

- TF-04-500** Tissue Forceps, 4x5 Teeth; 13cm (5")
- TF-04-575** Tissue Forceps, 4x5 Teeth; 14.5cm (5.75")
- TF-04-625** Tissue Forceps, 4x5 Teeth; 16cm (6.25")
- TF-04-800** Tissue Forceps, 4x5 Teeth; 20cm (8")

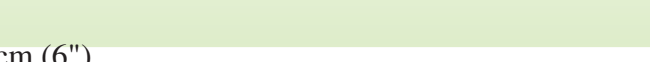

- TF-05-600** DeBakey Tissue Forceps, 2.7mm Jaw; 15cm (6")
- TF-05-775** DeBakey Tissue Forceps, 2.7mm Jaw; 19.5cm (7.75")
- +** **TF-05-120** DeBakey Tissue Forceps, 2.7mm Jaw; 30.5cm (12")
- +** **TF-05-140** DeBakey Tissue Forceps, 1.5mm Jaw; 35.5cm (14")
- TF-06-600** DeBakey Tissue Forceps, 2.0mm Jaw; 15cm (6")
- TF-07-600** DeBakey Tissue Forceps, 1.5mm Jaw; 15cm (6")

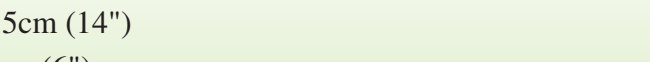

+ For Plus Size Patients

Other Forceps

Adson Forceps

AF-01-475 Adson Dressing Forceps, Straight, Extra Fine; 12cm (4.75")

AF-02-475 Adson Dressing Forceps, Straight, Standard; 12cm (4.75")

AF-02-600 Adson Dressing Forceps, Straight; 15cm (6")



AF-03-475 Adson DeBakey Forceps, Straight; 12cm (4.75")

AF-03-600 Adson DeBakey Forceps, Straight, 1.5mm Jaw; 15cm (6")

AF-04-600 Adson DeBakey Forceps, Straight, 2.0mm Jaw; 15cm (6")

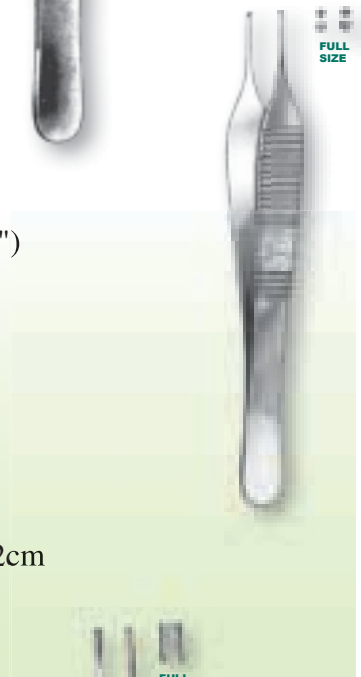

AF-05-475 Adson Tissue Forceps, Straight, Extra Fine, 1x2 Teeth; 12cm (4.75")

AF-06-475 Adson Tissue Forceps, Curved, 1x2 Teeth; 12cm (4.75")

AF-07-475 Adson Tissue Forceps, Straight, 1x2 Teeth; 12cm (4.75")

AF-13-600 Adson Tissue Forceps, Straight, 1x2 Teeth; 15cm (6")

AF-08-475 Adson Tissue Forceps, Straight, 2x3 Teeth; 12cm (4.75")

AF-09-600 Adson Tissue Forceps, Straight, 2x3 Teeth; 15cm (6")

AF-09-700 Adson Tissue Forceps, Straight, 2x3 Teeth; 18cm (7")

AF-10-475 Adson Tissue Forceps, Straight, Serrated, Extra Fine, 1x2 Teeth; 12cm (4.75")

AF-11-475 Adson Tissue Forceps, Curved, Serrated, 1x2 Teeth; 12cm (4.75")



AF-12-475 Adson Brown Tissue Forceps, Straight, 9x9 Teeth; 12cm (4.75")

AF-12-600 Adson Brown Tissue Forceps, Straight, 9x9 Teeth; 15cm (6")

AF-14-475 Adson Brown Tissue Forceps, Straight, 7x7 Teeth; 12cm (4.75")

Hemostatic Forceps

- HF-03-400** Hartman Mosquito Forceps, Straight; 10cm (4")
- HF-04-400** Hartman Mosquito Forceps, Curved; 10cm (4")



- HF-01-500** Halsted Micro Mosquito, Straight; 12.5cm (5")
- HF-02-500** Halsted Micro Mosquito, Curved; 12.5cm (5")
- HF-01-501** Halsted Micro Mosquito, 1x2 Teeth, Straight; 12.5cm (5")
- HF-02-501** Halsted Micro Mosquito, 1x2 Teeth, Curved; 12.5cm (5")
- HF-06-500** Halsted Mosquito Forceps, Straight; 12.5cm (5")
- HF-07-500** Halsted Mosquito Forceps, Curved; 12.5cm (5")
- HF-07-800** Halsted Mosquito Forceps, Curved; 20cm (8")
- HF-08-500** Halsted Mosquito Forceps, Angled; 12.5cm (5")



- HF-09-550** Crile Hemostatic Forceps, Straight; 14cm (5.5")
- HF-10-625** Crile Rankin Hemostatic Forceps, Straight; 16cm (6.25")
- HF-11-550** Crile Hemostatic Forceps, Curved; 14cm (5.5")
- HF-12-625** Crile Rankin Hemostatic Forceps, Curved; 16cm (6.25")

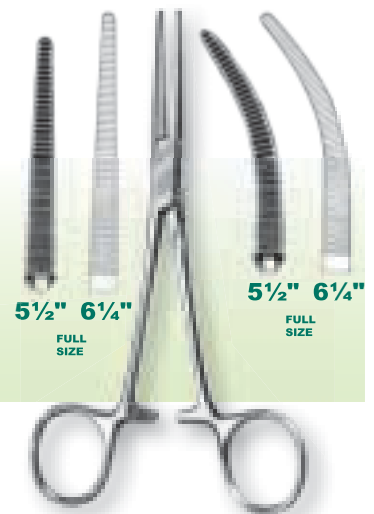

Hemostatic Forceps

- HF-13-550** Kelly Hemostatic Forceps, Straight; 14cm (5.5")
- HF-14-625** Kelly Rankin Hemostatic Forceps, Straight; 16cm (6.25")
- HF-15-550** Kelly Hemostatic Forceps, Curved; 14cm (5.5")
- HF-16-625** Kelly Rankin Hemostatic Forceps, Curved; 16cm (6.25")

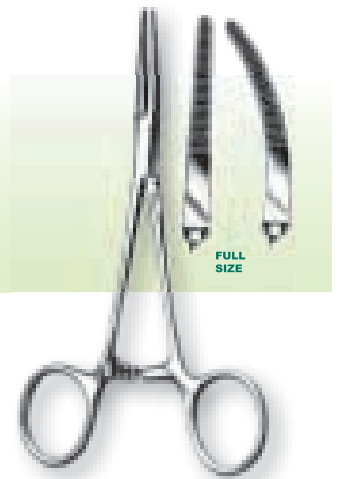

- HF-17-550** Kocher Hemostatic Forceps, Straight, 1x2 Teeth; 14cm (5.5")
- PLUS** **HF-17-120** Kocher Hemostatic Forceps, Straight, 1x2 Teeth; 30cm (12")
- PLUS** **HF-17-140** Kocher Hemostatic Forceps, Straight, 1x2 Teeth; 35.5cm (14")
- HF-18-550** Kocher Hemostatic Forceps, Curved, 1x2 Teeth; 14cm (5.5")
- PLUS** **HF-18-120** Kocher Hemostatic Forceps, Curved, 1x2 Teeth; 30cm (12")
- PLUS** **HF-18-140** Kocher Hemostatic Forceps, Curved, 1x2 Teeth; 35.5cm (14")

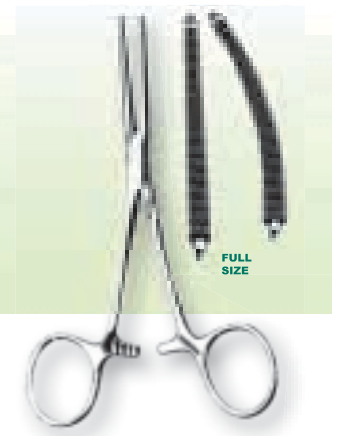

- HF-19-625** Rochester Pean Hemostatic Forceps, Straight; 16cm (6.25")
- HF-19-700** Rochester Pean Hemostatic Forceps, Straight; 18cm (7")
- HF-19-800** Rochester Pean Hemostatic Forceps, Straight; 20cm (8")
- HF-19-875** Rochester Pean Hemostatic Forceps, Straight; 22cm (8.75")
- HF-19-950** Rochester Pean Hemostatic Forceps, Straight; 24cm (9.5")
- HF-19-100** Rochester Pean Hemostatic Forceps, Straight; 26cm (10.25")
- PLUS** **HF-19-120** Rochester Pean Hemostatic Forceps, Straight; 30cm (12")
- PLUS** **HF-19-140** Rochester Pean Hemostatic Forceps, Straight; 35.5cm (14")
- HF-20-625** Rochester Pean Hemostatic Forceps, Curved; 16cm (6.25")
- HF-20-700** Rochester Pean Hemostatic Forceps, Curved; 18cm (7")
- HF-20-800** Rochester Pean Hemostatic Forceps, Curved; 20cm (8")
- HF-20-875** Rochester Pean Hemostatic Forceps, Curved; 22cm (8.75")
- HF-20-950** Rochester Pean Hemostatic Forceps, Curved; 24cm (9.5")
- HF-20-100** Rochester Pean Hemostatic Forceps, Curved; 26cm (10.25")
- PLUS** **HF-20-120** Rochester Pean Hemostatic Forceps, Curved; 30cm (12")
- PLUS** **HF-20-140** Rochester Pean Hemostatic Forceps, Curved; 35.5cm (14")



Hemostatic Forceps

- HF-21-625** Ochsner Pean Hemostatic Forceps, Straight, 1x2 Teeth; 16cm (6.25")
- HF-21-700** Ochsner Pean Hemostatic Forceps, Straight, 1x2 Teeth; 18cm (7")
- HF-21-800** Ochsner Pean Hemostatic Forceps, Straight, 1x2 Teeth; 20cm (8")
- HF-21-875** Ochsner Pean Hemostatic Forceps, Straight, 1x2 Teeth; 22cm (8.75")
- HF-21-950** Ochsner Pean Hemostatic Forceps, Straight, 1x2 Teeth; 24cm (9.5")
- HF-21-100** Ochsner Pean Hemostatic Forceps, Straight, 1x2 Teeth; 26cm (10.25")
- HF-21-110** Ochsner Pean Hemostatic Forceps, Straight, 1x2 Teeth; 28cm (11")
- PLUS** **HF-21-120** Ochsner Pean Hemostatic Forceps, Straight, 1x2 Teeth; 30cm (12")
- HF-22-625** Ochsner Pean Hemostatic Forceps, Curved, 1x2 Teeth; 16cm (6.25")
- HF-22-700** Ochsner Pean Hemostatic Forceps, Curved, 1x2 Teeth; 18cm (7")
- HF-22-800** Ochsner Pean Hemostatic Forceps, Curved, 1x2 Teeth; 20cm (8")
- HF-22-875** Ochsner Pean Hemostatic Forceps, Curved, 1x2 Teeth; 22cm (8.75")
- HF-22-950** Ochsner Pean Hemostatic Forceps, Curved, 1x2 Teeth; 24cm (9.5")
- HF-22-100** Ochsner Pean Hemostatic Forceps, Curved, 1x2 Teeth; 26cm (10.25")
- HF-22-110** Ochsner Pean Hemostatic Forceps, Curved, 1x2 Teeth; 28cm (11")
- PLUS** **HF-22-120** Ochsner Pean Hemostatic Forceps, Curved, 1x2 Teeth; 30cm (12")

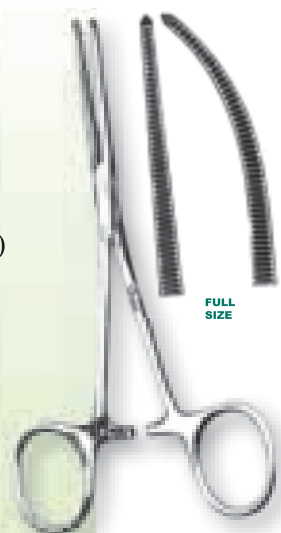

- HF-23-600** Pennington Tissue Holder Forceps; 15cm (6")
- HF-23-800** Pennington Tissue Holder Forceps; 20cm (8")





- HF-24-550** Providence Hospital Clamps, Straight; 14cm (5.5")
- HF-25-550** Providence Hospital Clamps, Curved; 14cm (5.5")

- HF-26-725** Baby Mixer Hemostatic Forceps; 18cm (7.25")
- PLUS** **HF-26-120** Baby Mixer Hemostatic Forceps; 30cm (12")
- PLUS** **HF-26-140** Baby Mixer Hemostatic Forceps; 35.5cm (14")



Other Forceps

Sponge Forceps

- SF-01-700** Foerster Sponge Forceps, Straight, Serrated Jaws; 18cm (7")
- SF-01-950** Foerster Sponge Forceps, Straight, Serrated Jaws; 25cm (9.5")
-  **SF-01-120** Foerster Sponge Forceps, Straight, Serrated Jaws; 30cm (12")
-  **SF-01-140** Foerster Sponge Forceps, Straight, Serrated Jaws; 35.5cm (14")
- SF-02-700** Foerster Sponge Forceps, Straight, Smooth Jaws; 18cm (7")
- SF-02-950** Foerster Sponge Forceps, Straight, Smooth Jaws; 25cm (9.5")
- SF-03-700** Foerster Sponge Forceps, Curved, Serrated Jaws; 18cm (7")
- SF-03-950** Foerster Sponge Forceps, Curved, Serrated Jaws; 25cm (9.5")
- SF-04-700** Foerster Sponge Forceps, Curved, Smooth Jaws; 18cm (7")
- SF-04-950** Foerster Sponge Forceps, Curved, Smooth Jaws; 25cm (9.5")

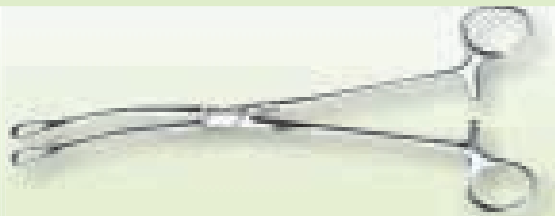

- SF-05-950** Bergmann Sponge Forceps, Straight, 8mm Serrated Jaws; 25cm (9.5")
- SF-06-950** Bergmann Sponge Forceps, Curved, 8mm Serrated Jaws; 25cm (9.5")

Miscellaneous Forceps

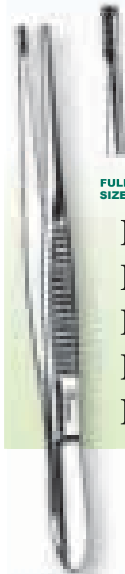

FULL
SIZE

- MF-01-600** Brown Tissue Forceps, 9x9 Teeth, 15cm (6")
- MF-01-800** Brown Tissue Forceps, 9x9 Teeth, 20cm (8")
- MF-01-900** Brown Tissue Forceps, 9x9 Teeth, 23cm (9")
- MF-01-950** Brown Tissue Forceps, 9x9 Teeth, 24cm (9.5")
- MF-01-100** Brown Tissue Forceps, 9x9 Teeth, 25.5cm (10")

- MF-02-550** Heaney Tissue Forceps, 1x2 Teeth, 14cm (5.5")
- MF-03-550** Heaney Tissue Forceps, 2x3 Teeth, 14cm (5.5")

- MF-03-675** Bonney Tissue Forceps, 1x2 Teeth, 17cm (6.75")
- MF-04-675** Bonney Tissue Forceps, 2x3 Teeth, 17cm (6.75")



FULL
SIZE

Miscellaneous Forceps

- MF-05-700** Taylor Dressing Forceps; 18cm (7")
- MF-06-700** Taylor Tissue Forceps, 1x2 Teeth; 18cm (7")
- MF-07-700** Taylor Dressing Forceps, Bayonet; 18cm (7")
- MF-08-700** Taylor Tissue Forceps, Bayonet, 1x2 Teeth; 18cm (7")



- MF-09-700** Potts Smith Dressing Forceps; 18cm (7")
- MF-09-825** Potts Smith Dressing Forceps; 21cm (8.25")
- MF-09-975** Potts Smith Dressing Forceps; 25cm (9.75")
-  **MF-09-120** Potts Smith Dressing Forceps; 30cm (11.75")
- MF-10-700** Potts Smith Tissue Forceps, 1x2 Teeth; 18cm (7")
- MF-10-825** Potts Smith Tissue Forceps, 1x2 Teeth; 21cm (8.25")
- MF-10-975** Potts Smith Tissue Forceps, 1x2 Teeth; 25cm (9.75")
-  **MF-10-120** Potts Smith Tissue Forceps, 1x2 Teeth; 30cm (11.75")

- MF-11-675** Gerald Dressing Forceps, Straight; 17cm (6.75")
- MF-12-675** Gerald Tissue Forceps, Straight, 1x2 Teeth; 17cm (6.75")
- MF-13-675** Gerald Dressing Forceps, Curved; 17cm (6.75")
- MF-14-675** Gerald Tissue Forceps, Curved, 1x2 Teeth; 17cm (6.75")



- MF-15-675** Selman (Mini Russian) Forceps; 15cm (6")
- MF-15-800** Selman (Mini Russian) Forceps; 20cm (8")
- MF-15-100** Selman (Mini Russian) Forceps; 25cm (10")

Other Forceps

Miscellaneous Forceps



MF-17-900 Mayo Russian Forceps; 23cm (9")

- MF-16-600** Russian Tissue Forceps; 15cm (6")
- MF-16-800** Russian Tissue Forceps; 20cm (8")
- MF-16-100** Russian Tissue Forceps; 25cm (10")
-  **MF-16-120** Russian Tissue Forceps; 30cm (12")

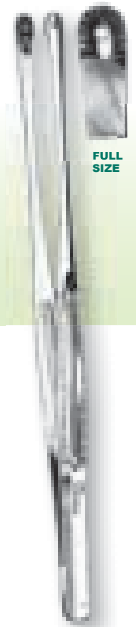

- MF-18-100** Singley Cervical Forceps; 25cm (10")
-  **MF-18-120** Singley Cervical Forceps; 30cm (12")

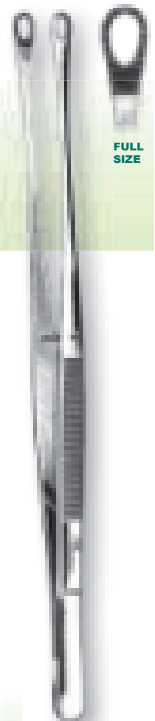

MF-20-700 Ferris Smith Tissue Forceps, 1x2 Teeth; 18cm (7")



- MF-17-500** Semken Tissue Forceps, Straight, 1x2 Teeth; 13cm (5")
- MF-17-600** Semken Tissue Forceps, Straight, 1x2 Teeth; 15cm (6")
- MF-18-600** Semken Tissue Forceps, Serrated; 15cm (6")



Not Pictured:

- MF-19-800** Lane Tissue Forceps, 1x2 Teeth; 20cm (8")
- MF-21-775** Schindt Tonsil Forceps, Curved; 19cm (7.25")

NH-21-450 Webster Needle Holder, Straight, Smooth Jaws, Tungsten Carbide Inserts; 11.5cm (4.5")

NH-07-500 Webster Needle Holder, Serrated Jaws; 13cm (5")

NH-08-500 Webster Needle Holder, Smooth Jaws; 13cm (5")

NH-21-500 Webster Needle Holder, Straight, Smooth Jaws, Tungsten Carbide Inserts; 13cm (5")

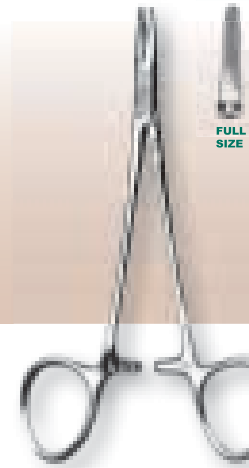

NH-22-475 Derf Needle Holder, Straight, Serrated Jaws; Tungsten Carbide Inserts, 12cm (4.75")

NH-01-500 Derf Needle Holder, Serrated Jaws; 13cm (5")

NH-23-600 Crile-Wood Needle Holder, Straight, Tungsten Carbide Inserts; 15cm (6")

NH-11-600 Crile-Wood Needle Holder, Serrated Jaws; 15cm (6")



Needle Holders

NH-24-600 DeBakey Needle Holder (Crile-Wood), Straight, Tungsten Carbide Inserts; 15cm (6")

NH-25-600 DeBakey Needle Holder, Curved, Tungsten Carbide Inserts; 15cm (6")

NH-24-700 DeBakey Needle Holder (Crile-Wood), Straight, Tungsten Carbide Inserts; 18cm (7")

NH-25-700 DeBakey Needle Holder, Curved, Tungsten Carbide Inserts; 18cm (7")

NH-24-800 DeBakey Needle Holder (Crile-Wood), Straight, Tungsten Carbide Inserts; 20cm (8")

NH-25-800 DeBakey Needle Holder, Curved, Tungsten Carbide Inserts; 20cm (8")

NH-24-900 DeBakey Needle Holder (Crile-Wood), Straight, Tungsten Carbide Inserts; 23cm (9")

NH-25-900 DeBakey Needle Holder, Curved, Tungsten Carbide Inserts; 23cm (9")

NH-24-100 DeBakey Needle Holder (Crile-Wood), Straight, Tungsten Carbide Inserts; 26cm (10.25")

NH-25-100 DeBakey Needle Holder, Curved, Tungsten Carbide Inserts; 26cm (10.25")

NH-24-120 DeBakey Needle Holder (Crile-Wood), Straight, Tungsten Carbide Inserts; 30.5cm (12")

NH-25-120 DeBakey Needle Holder, Curved, Tungsten Carbide Inserts; 30.5cm (12")

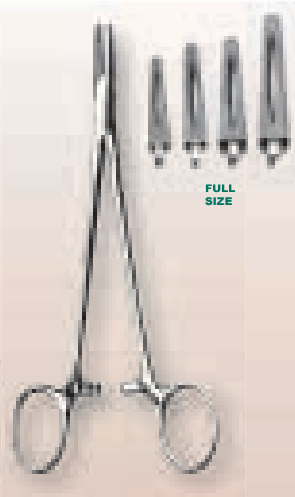
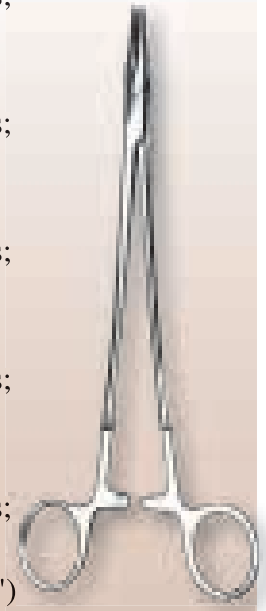

NH-26-550 Mayo Hegar Needle Holder, Straight, Tungsten Carbide Inserts; 14cm (5.5")

NH-26-625 Mayo Hegar Needle Holder, Straight, Tungsten Carbide Inserts; 16cm (6.25")

NH-26-700 Mayo Hegar Needle Holder, Straight, Tungsten Carbide Inserts; 18cm (7")

NH-26-800 Mayo Hegar Needle Holder, Straight, Tungsten Carbide Inserts; 20cm (7")

NH-26-900 Mayo Hegar Needle Holder, Straight, Tungsten Carbide Inserts; 23cm (9")

NH-26-105 Mayo Hegar Needle Holder, Straight, Tungsten Carbide Inserts; 26.5cm (10.5")

NH-12-600 Mayo Hegar Needle Holder, Straight, Serrated Jaws; 15cm (6")

NH-12-700 Mayo Hegar Needle Holder, Straight, Serrated Jaws; 18cm (7")

NH-12-800 Mayo Hegar Needle Holder, Straight, Serrated Jaws; 20cm (8")

NH-12-900 Mayo Hegar Needle Holder, Straight, Serrated Jaws; 23cm (9")

NH-12-105 Mayo Hegar Needle Holder, Straight, Serrated Jaws; 26.5cm (10.5")

NH-12-120 Mayo Hegar Needle Holder, Straight, Serrated Jaws; 30cm (12")

NH-27-700 New Orleans Needle Holder, Straight, Tungsten Carbide Inserts; 18cm (7")



NH-29-105 Masson Needle Holder, Straight, Tungsten Carbide Inserts; 26.5cm (10.5")

NH-14-105 Masson Needle Holder, Serrated Jaws; 26.5cm (10.5")

Needle Holders

NH-30-925 Stratte Needle Holder, Curved, S-Shaped Shaft, Tungsten Carbide Inserts; 23.5cm (9.25")

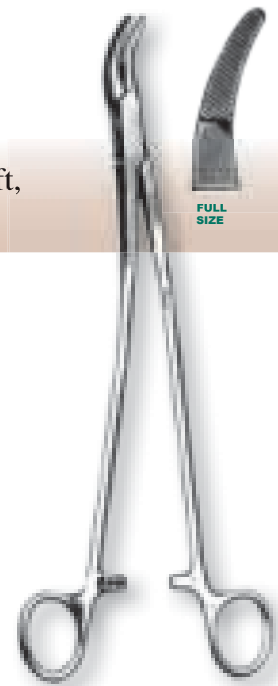

NH-31-700 Sarot Needle Holder, Straight, Tungsten Carbide Inserts; 18cm (7")

NH-31-800 Sarot Needle Holder, Straight, Tungsten Carbide Inserts; 20cm (8")

NH-31-875 Sarot Needle Holder, Straight, Tungsten Carbide Inserts; 22cm (8.75")

NH-31-100 Sarot Needle Holder, Straight, Tungsten Carbide Inserts; 26.5cm (10.5")

NH-13-625 Sarot Needle Holder, Serrated Jaws; 16cm (6.25")

NH-13-105 Sarot Needle Holder, Serrated Jaws; 26.5cm (10.5")



NH-32-825 Heaney Needle Holder, Curved, Tungsten Carbide Inserts; 21cm (8.25")

NH-32-105 Heaney Needle Holder, Curved, Tungsten Carbide Inserts; 26.5cm (10.5")

PLUS **NH-32-140** Heaney Needle Holder, Curved, Tungsten Carbide Inserts; 35.5cm (14")

NH-19-825 Heaney Needle Holder, Curved, Serrated Jaws; 21cm (8.25")

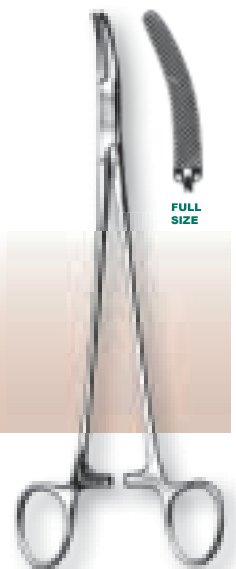

NH-33-800 Bozeman Needle Holder, Straight, Angled Shaft, Tungsten Carbide Inserts; 20cm (8")

NH-33-900 Bozeman Needle Holder, Straight, Angled Shaft, Tungsten Carbide Inserts; 23cm (9")

NH-33-100 Bozeman Needle Holder, Straight, Angled Shaft, Tungsten Carbide Inserts; 26cm (10.25")

NH-33-120 Bozeman Needle Holder, Straight, Angled Shaft, Tungsten Carbide Inserts; 30cm (11.75")

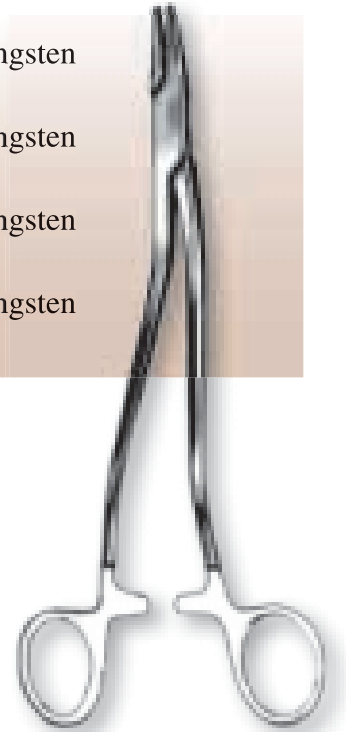

NH-34-800 Bozeman-Heaney Needle Holder, Curved, Angled Shaft, Tungsten Carbide Inserts; 20cm (8")

NH-34-105 Bozeman-Heaney Needle Holder, Curved, Angled Shaft, Tungsten Carbide Inserts; 26.5cm (10.5")

NH-36-800 Mathieu Needle Holder, Straight, Narrow Jaws, Tungsten Carbide Inserts; 20cm (8")

NH-37-900 Mathieu Needle Holder, Straight, Tungsten Carbide Inserts; 23cm (9")

NH-18-550 Mathieu Needle Holder, Right or Left Handed, Serrated Jaws; 14cm (5.5")

NH-18-675 Mathieu Needle Holder, Right or Left Handed, Serrated Jaws; 17cm (6.75")

NH-18-800 Mathieu Needle Holder, Right or Left Handed, Serrated Jaws; 20cm (8")

NH-38-550 Olsen-Hegar Needle Holder with Scissors, Straight, Tungsten Carbide Inserts; 14cm (5.5")

NH-38-675 Olsen-Hegar Needle Holder with Scissors, Straight, Tungsten Carbide Inserts; 17cm (6.75")



Needle Holders

NH-02-500 Converse (Derf) Needle Holder, Longitudinally Serrated Jaws; 13cm (5")

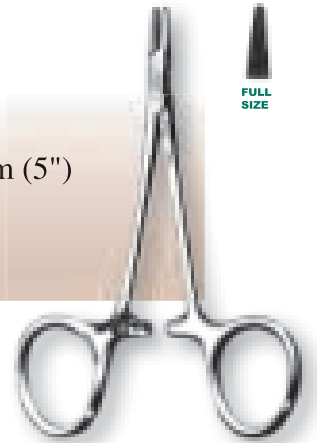

FULL
SIZE

NH-04-500 Neivert Needle Holder, Smooth Jaws, Off-Set Ring; 13cm (5")



FULL
SIZE

NH-05-500 Brown Needle Holder, Serrated Convex Jaws; 13cm (5")

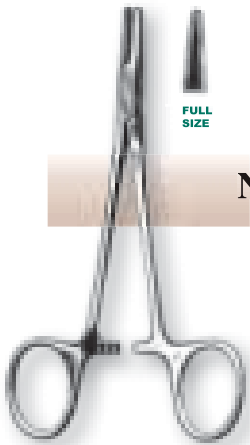

FULL
SIZE

Not Pictured:

NH-45-525 Kilner Needle Holder, Serrated Jaws, Tungsten Carbide Inserts "S Curved"; 14cm (5.50")

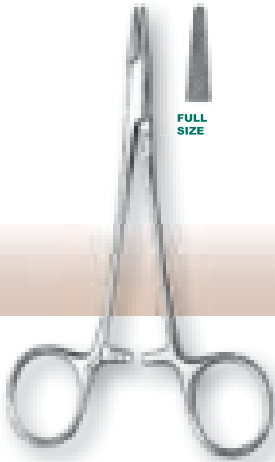

NH-09-525 Halsey Needle Holder, Smooth Jaws; 13.5cm (5.25")

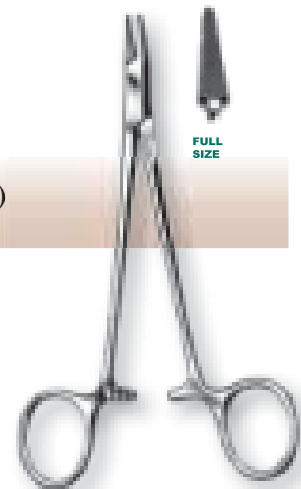

NH-10-550 Baumgartner Needle Holder, Serrated Jaws; 14cm (5.5")



NH-16-475 Olsen-Hegar Needle Holder with Scissors, Smooth Jaws; 12cm (4.75")

NH-17-475 Olsen-Hegar Needle Holder with Scissors, Serrated Jaws; 12cm (4.75")

NH-17-550 Olsen-Hegar Needle Holder with Scissors, Serrated Jaws; 14cm (5.5")

NH-17-625 Olsen-Hegar Needle Holder with Scissors, Serrated Jaws; 16cm (6.25")

NH-41-100 Nolan Needle Holder, Straight, Heavy Box Lock, Tungsten Carbide Inserts; 25.5cm (10")

 **NH-41-120** Nolan Needle Holder, Straight, Heavy Box Lock, Tungsten Carbide Inserts; 30.5cm (12")

 **NH-41-140** Nolan Needle Holder, Straight, Heavy Box Lock, Tungsten Carbide Inserts; 35.5cm (14")

Other Retractors

Self Retaining Retractors

- SR-04-004** Balfour Retractor Center Blade, 6cm (2.5")
- SR-05-700** Balfour Retractor with Open Ended Blades, 5cm (2") Deep; Spread: 18cm (7")
- SR-05-100** Balfour Retractor with Open Ended Blades, 5cm (2") Deep; Spread: 25cm (10")
- SR-06-700** Balfour Retractor with Open Ended Blades, 10cm (4") Deep; Spread: 18cm (7")
- SR-06-100** Balfour Retractor with Open Ended Blades, 10cm (4") Deep; Spread: 25cm (10")
- SR-07-100** Balfour Retractor with 2 Sets Interchangeable Blades, 5cm (2") Deep and 10cm (4") Deep; Spread: 25cm (10")
- SR-08-001** Balfour Center Blade, 2.5cm (1") Deep; Length: 2.5cm (1")
- SR-08-002** Balfour Center Blade, 7.5cm (3") Deep; Length: 5cm (2")
- SR-08-004** Balfour Center Blade, 6cm (2.5") Deep; Length: 10cm (4")
- SR-08-400** Balfour Extra Arm, Right
- SR-09-400** Balfour Extra Arm, Left

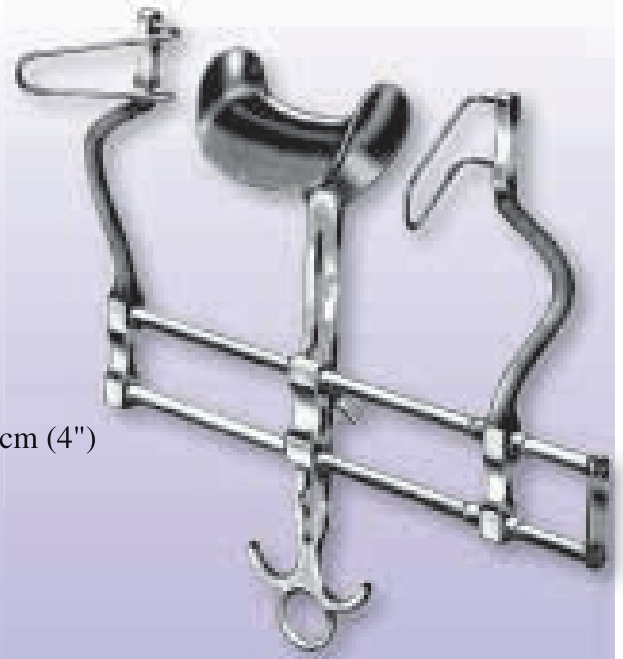

- SR-10-200** Kirschner Abdominal Retractor with 4 Blades; Size: 2 each 40mm x 50mm (1.75" x 1.25"), 2 each 50mm x 65mm (2" x 2.75")
- SR-10-125** Kirschner Blade; Size: 40mm x 55mm (1.75" x 1.25")
- SR-10-275** Kirschner Blade; Size: 50mm x 65mm (2" x 2.75")
- SR-10-650** Kirschner Blade; Size: 78mm x 65mm (3.25" x 2.75")
- SR-10-150** Kirschner Blade; Size: 105mm x 35mm (4" x 1.5")
- SR-10-350** Kirschner Blade; Size: 60mm x 85mm (2.5" x 3.5")
- SR-10-325** Kirschner Blade; Size: 80mm x 90mm (3.25" x 3.5")
- SR-10-100** Kirschner Blade; Size: 25mm x 25mm (1" x 1")



- SR-01-600** Gelpi Perineal Retractor; 15.5cm (6")
- SR-01-700** Gelpi Perineal Retractor; 18cm (7")
- SR-02-700** Gelpi Perineal Retractor with Ball Stops; 18cm (7")



Self Retaining Retractors

SR-09-100 O'Sullivan O'Connor Abdominal Retractor Complete with 3 Blades; Size: 2 each 4.5cm x 9cm (1.75" x 3.25"), 1 each 6.5cm x 10.25cm (2.75" x 4.1")

SR-09-325 O'Sullivan O'Connor Blade; Size: 4.5cm x 9cm (1.75" x 3.25")

SR-09-410 O'Sullivan O'Connor Blade; Size: 6.5cm x 10.25cm (2.75" x 4.1")

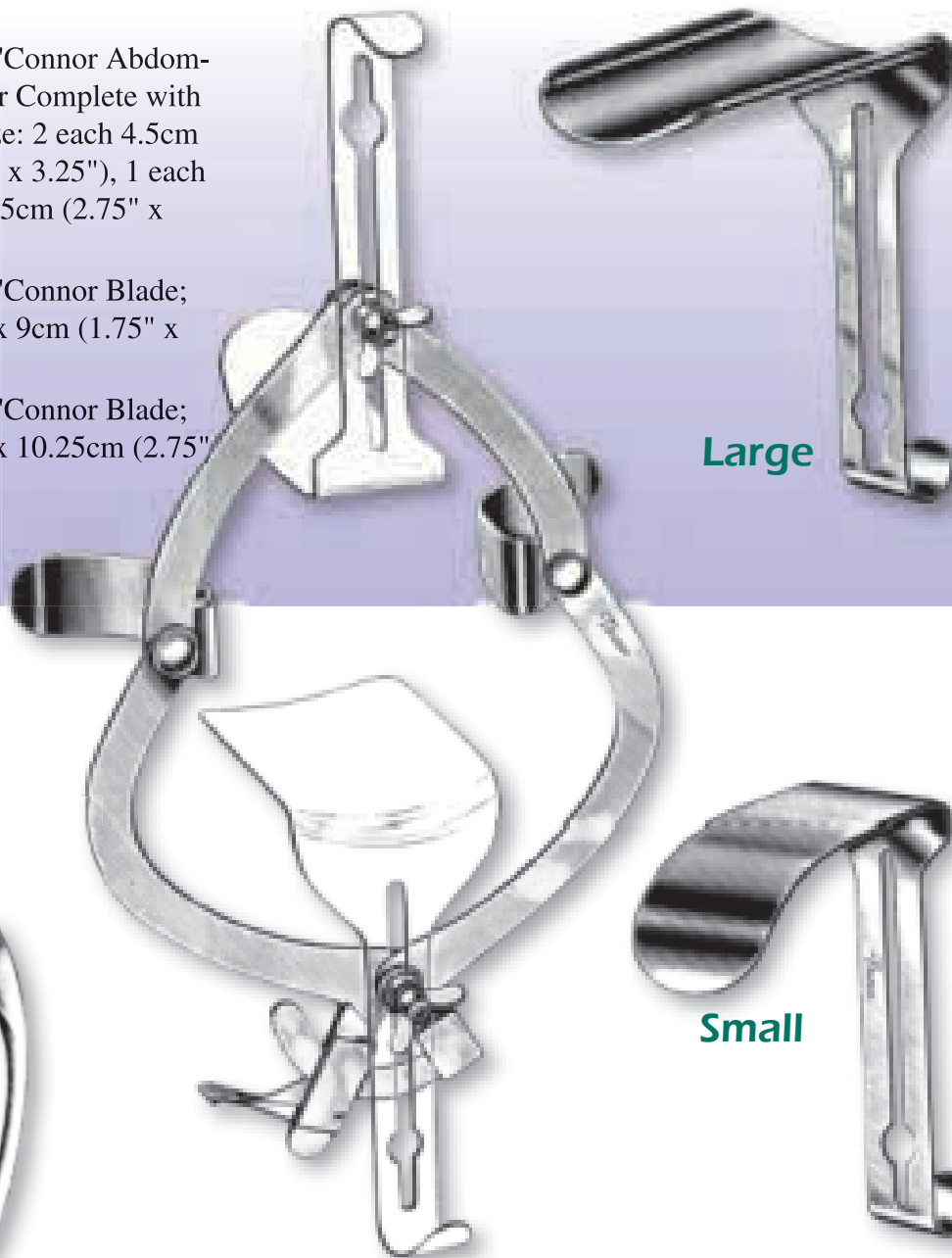

Large

Small

SR-03-675 Mayo Adams Retractor with 2 Blades; 17cm (6.75")

SR-04-675 Mayo Adams Retractor with 3 Blades; 17cm (6.75")

Other Retractors

Deaver Retractors

- DR-01-700** Deaver Retractor; Size: 19mm x 18cm (.75" x 7")
- DR-01-850** Deaver Retractor; Size: 22mm x 21cm (.9" x 8.5")
- DR-01-900** Deaver Retractor; Size: 25mm x 23cm (1" x 9")
- DR-01-105** Deaver Retractor; Size: 25mm x 27cm (1" x 10.5")
- DR-01-120** Deaver Retractor; Size: 25mm x 30cm (1" x 12")
- DR-01-130** Deaver Retractor; Size: 25mm x 33cm (1" x 13")
- DR-01-140** Deaver Retractor; Size: 25mm x 36cm (1" x 14")
- DR-01-150** Deaver Retractor; Size: 38mm x 30cm (1.5" x 12")
- DR-01-212** Deaver Retractor; Size: 51mm x 30cm (2" x 12")
- DR-01-312** Deaver Retractor; Size: 76mm x 30cm (3" x 12")



Ribbon Retractors

- RR-01-125** Ribbon Retractor, Malleable; Size: .6cm x 17.8cm (1.25" x 7")
- RR-01-150** Ribbon Retractor, Malleable; Size: 1.3cm x 17.8cm (1.5" x 7")
- RR-01-075** Ribbon Retractor, Malleable; Size: 1.9cm x 17.8cm (.75" x 7")
- RR-01-100** Ribbon Retractor, Malleable; Size: 2.5cm x 17.8cm (1" x 7")
- RR-01-130** Ribbon Retractor, Malleable; Size: 1.9cm x 33cm (.75" x 13")
- RR-01-113** Ribbon Retractor, Malleable; Size: 2.5cm x 33cm (1" x 13")
- RR-01-153** Ribbon Retractor, Malleable; Size: 3.8cm x 33cm (1.5" x 13")
- RR-01-213** Ribbon Retractor, Malleable; Size: 5.1cm x 33cm (2" x 13")
- RR-01-513** Ribbon Retractor, Malleable; Size: 6.8cm x 33cm (2.5" x 13")
- RR-01-313** Ribbon Retractor, Malleable; Size: 7.6cm x 33cm (3" x 13")



Miscellaneous Retractors

MR-01-850 U.S. Army Retractor, Set of 2; 21.5cm (8.5")



MR-04-100 Richardson Eastman Retractor, Double Ended, Small; 26cm (10.25")

MR-04-110 Richardson Eastman Retractor, Double Ended, Large; 28cm (11")

MR-04-200 Richardson Eastman Retractor, Double Ended, Set of 2; 26cm (10.25") and 28cm (11")

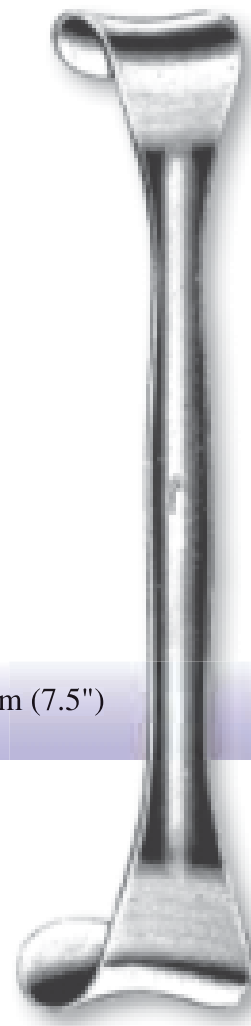
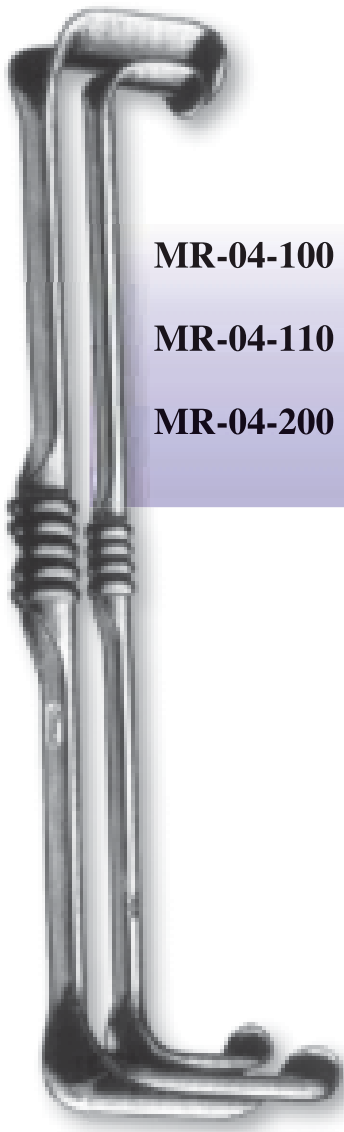

MR-03-750 Goelet Retractor, Double Ended; 19cm (7.5")

Other Retractors

Miscellaneous Retractors

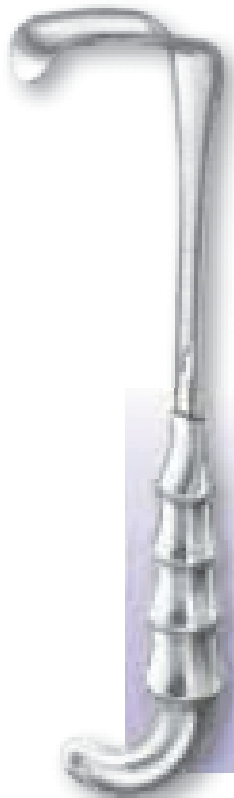

MR-05-100 Richardson Retractor, 2cm x 2.5cm (.75" x 1") Blade; 24cm (9.5")

MR-05-175 Richardson Retractor, 2.5cm x 3cm (1" x 1.75") Blade; 25cm (9.75")

MR-12-975 Richardson Retractor, 4.4cm x 3.8cm (1.75" x 1.5") Blade; 25cm (9.75")

MR-11-975 Richardson Retractor, 2.8cm x 2cm (1.1" x .75") Blade; 25cm (9.75")

MR-05-150 Richardson Retractor, 4cm x 4cm (1.5" x 1.5") Blade; 26cm (10.25")

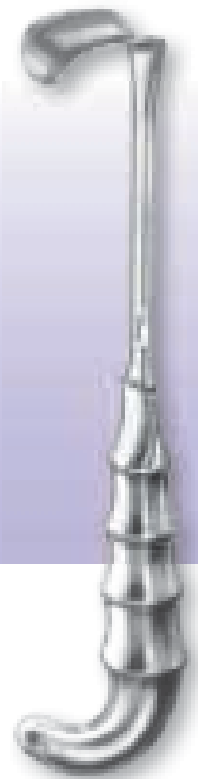

MR-06-200 Kelly Retractor, 4cm x 5cm (1.5" x 2") Blade; 26cm (10.25")

MR-06-250 Kelly Retractor, 5cm x 6cm (2" x 2.5") Blade; 26cm (10.25")

MR-06-300 Kelly Retractor, 6cm x 7.5cm (2.5" x 3") Blade; 26cm (10.25")

MR-06-350 Kelly Retractor, 7.5cm x 9cm (3" x 3.5") Blade; 26cm (10.25")

MR-07-250 Doyen Abdominal Retractor, 4.5cm x 6cm (1.75" x 2.5") Blade; 22cm (8.5")

MR-07-325 Doyen Abdominal Retractor, 5cm x 8.5cm (2" x 3.25") Blade; 22cm (8.5")

MR-07-350 Doyen Abdominal Retractor, 5.5cm x 9cm (2.25" x 3.5") Blade; 22cm (8.5")

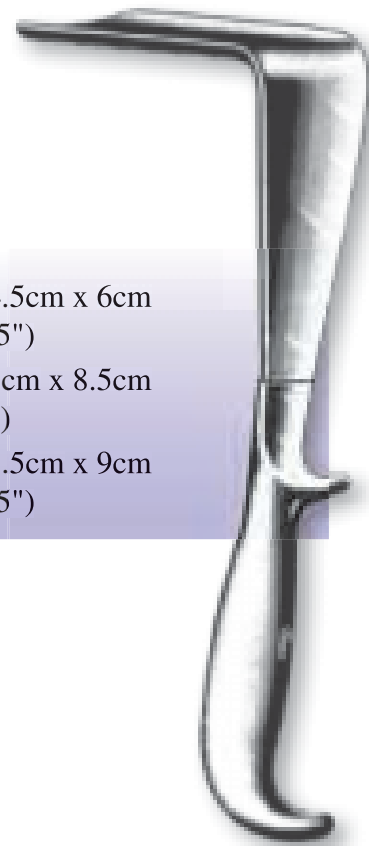

Miscellaneous Retractors

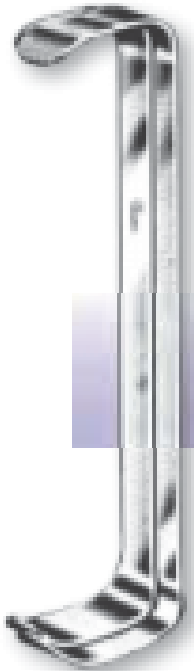

MR-08-100 Mayo Abdominal Retractor,
6cm (2.4") Blade; 25.5cm (10")

MR-08-110 Mayo Abdominal Retractor,
6cm (2.4") Blade; 28cm (11")

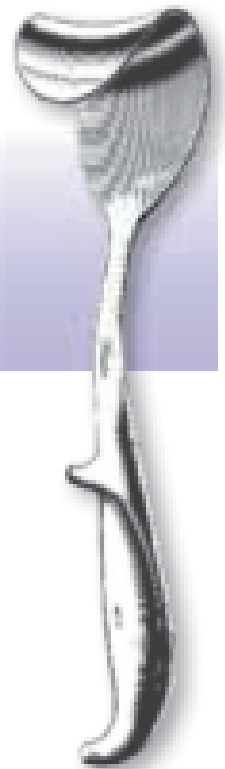

MR-09-600 Farabeuf Retractors,
Set of 2; 15cm (6")



MR-10-525 Parker Retractors, Set of 2;
13.5cm (5.25")

MR-10-700 Parker Retractors, Set of 2;
18cm (7")

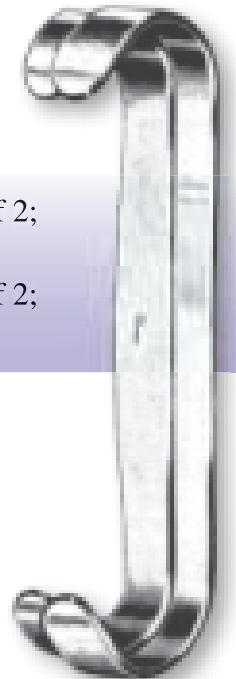

 **MR-12-120** Cushing Vein Retractor, 30.5cm (12")

 **MR-12-140** Cushing Vein Retractor, 35.5cm (14")



Miscellaneous Instruments

Towel Clamps

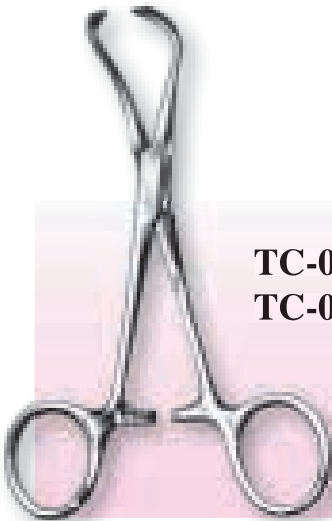

TC-02-400 Lorna (Edna) Towel Clamp; 10cm (4")

TC-02-525 Lorna (Edna) Towel Clamp; 13cm (5.25")



TC-01-350 Backhaus Towel Clamp; 9cm (3.5")

TC-01-525 Backhaus Towel Clamp; 13cm (5.25")

Dermal Punches

DP-01-100 Keyes Dermal Punch Set with 5 Punches; 2mm thru 7mm

DP-01-200 Keyes Dermal Punch, 2mm; 10cm (4")

DP-01-300 Keyes Dermal Punch, 3mm; 10cm (5")

DP-01-400 Keyes Dermal Punch, 4mm; 10cm (6")

DP-01-500 Keyes Dermal Punch, 5mm; 10cm (4")

DP-01-600 Keyes Dermal Punch, 6mm; 10cm (4")

DP-01-700 Keyes Dermal Punch, 7mm; 10cm (4")

DP-01-800 Keyes Dermal Punch, 8mm; 10cm (4")



Scalpel Handles

SH-01-003 Scalpel Handle #3 for Blade Sizes #10, 11, 12, 12D, 15, 15C, 17, 18; 13cm (5")

SH-01-400 Scalpel Handle #4 for Blade Sizes #20, 21, 22, 23

SH-03-007 Scalpel Handle #7 for Blade Sizes #10, 11, 12, 12D, 15, 15C, 17, 18;
Graduated in Centimeters; 16cm (6.25")

B&H SURGICAL

Specializing in OB/GYN and GI Products

STERILIZATION AND REPROCESSING FOR REUSABLE TEFLON INSTRUMENT

Institutional device reprocessing should occur in facilities that are adequately designed, equipped, monitored and staffed by trained personnel.

Sterilize per your institutions validated procedures and cycle parameters. The following parameters for cleaning and the four most commonly utilized methods of sterilization are recommended as guidelines for validation.

NOTE: REPROCESSING THESE DEVICES DICTATES THAT IT UNDERGOES A THOROUGH CLEANING PRIOR TO STERILIZATION.

CLEANING □

CAUTION: AVOID USE OF ABRASIVE CLEANERS OR SOLVENTS

1. Rinse the device thoroughly with sterile, purified water to remove any accumulated debris.
2. Hand wash the surface of the device with a using a soft bristled cleaning brush and enzyme cleaner *e.g. Terg-a-zyme solution (Alconox, Inc.)*, to remove visible residual debris.
3. After hand-washing, the surface is to be thoroughly flushed with sterile, purified water until no visible detergent residual remains.
4. Thoroughly dry the device using a sterile wipe.

STERILIZATION □

CAUTION: DO NOT GAMMA STERILIZE.

1. **STEAM/GRAVITY DISPLACEMENT:** Double wrap device in muslin *i.e. CSR blue hospital wr ap* and place (single layer) in a production type steam sterilization vessel. Process at 132 C for a 30-minute cycle.
2. **STEAM/PRE-V ACUUM:** Double wrap device n muslin *i.e. CSR blue hospital wr ap* and place (single layer) in a production type steam sterilization vessel. Process at 132 C for a four minute cycle. **CAUTION: THIS FORM OF STERILIZATION MAY REDUCE THE LIFETIME OF YOUR DEVICE.**
3. **ETHYLENE O XIDE (EO):** Double wrap device in muslin *i.e. CSR blue hospital wrap* and place (single layer) in a production type EO sterilizer. Process at a nominal 600mg/L EO concentration using Oxyfume 2000 (10:90) gas for a full two hour cycle. Immediately following the exposure cycle, aerate for 18 hours at 122 F.
4. **CHEMICAL (CIDEX) STERILIZATION:** Totally immerse the device in Cidex activated glutaraldehyde solution (Johnson & Johnson Medical, Inc.). Expose the device to the Cidex for ten hours at 25 C. Following chemical exposure, rinse and flush the device with copious amounts of sterile water for a minimum of one minute, three separate times.

CARE AND CLEANING OF THE JARCO SELF-RETAINING CANNULA & THE KAHN UTERINE TRIGGER CANNULA

1. HANDLING

All Instruments must be cleaned thoroughly and sterilized prior to their first usage. They should be handled with care during transportation, cleaning, sterilization, and storage. Extra care should be taken when handling tips and removable parts (including instrument rest, tips, screws, locking collars, acorns and stopcock.)

Surgical instruments tend to corrode or malfunction if they come into contact with aggressive or caustic solutions. In cleaning your instruments, please be sure not to use any corrosive cleaning agents or acids, and that the cleaning agent has a neutral pH level.

2. INSPECTION

Prior to each use, please examine each surgical instrument for breaks, cracks, and malfunction. Pay specific attention to the tips and edges, and check the stopcock valve for obstructions. Do not use if damaged.

3. CLEANING & MAINTENANCE

Surgical instruments should be cleaned thoroughly and dried after every use. Clean the instruments and all parts with a nylon brush and mild disinfecting solution to remove all blood and debris. We recommend a high-grade surgical instrument cleaner that is neutral with a pH of 7. Before sterilization of the instrument, rinse off with de-mineralized water, making sure that all cleaning residues are removed. Then dry the instrument thoroughly before the sterilization process. Ensure that all parts are cleaned thoroughly to guarantee the proper function of the instrument. Ultrasonic cleaning is recommended.

4. STERILIZATION

We strongly recommend the sterilization of the stainless steel parts of your cannula in autoclaves at 270 Fahrenheit, 132 Celsius for 15 minutes. All rubber parts (acorn and collar) should be cold soaked. All Teflon® parts (white acorn and tip) may be either cold soaked or autoclaved. When cold soaking use CIDEX™ or equivalent, and follow the manufacturer's recommendations. Hot-air sterilizing and "flash" sterilizing are not recommended.

CARE, CLEANING & STERILIZATION OF NON-CONDUCTIVE INSTRUMENTS

Rinsing and cleaning needs to happen immediately after use for decontamination. Adherent particles may resist cleaning or cause staining.

Instruments must be completely cleaned of all foreign matter with specific care focused on channels and moving parts in contact with body tissue and fluids. Precise cleaning is key prior to sterilization.

1. Follow the "General Maintenance Guidelines" for suitable handling of instruments.
2. Completely soak instruments in cleaning agent.
3. Avoid use of eroding cleaning agents (i.e. bleach).
4. Never clean electrosurgical and laser coated instruments in a glass bead sterilizer.
5. To dismantle, remove the thumbnut holding the yoke/ upper assembly to lower blade.
6. Remove tubing and expel according to hospital protocol if disposable smoke tubing is used.
7. Use warm water and a mild soap.
8. Do not use a harsh cleaning solution.
9. Do not soak coated instruments in CIDEX or other caustic cold sterilization solutions.
10. Cleaning agents and rinses at or near neutral pH (7.0) are recommended.
11. A soft bristle brush (similar to a toothbrush) should be used.
12. Round bristle brushes are recommended to clean inside channels of smoke tubes, if present.
13. Immerse and extensively rinse the instruments in warm tap water to remove cleaning agents.

14. An enzymatic cleaner should be used to remove protein deposits on the instruments. Follow enzymatic manufacturer's instructions and rinse thoroughly.
15. A final rinse of distilled water is recommended.
16. Inspect the instrument coating for nicks or cuts; verify that no metal is visible underneath the coating.
17. Handle with care. Hard contact with other instruments, hard surfaces or sharp objects can damage the non-conductive coating.
18. Delicate hooks or tenacula should receive special attention to avoid breakage
19. Do not place coated instruments in an ultrasonic cleaner.

TO CLEAN:

1. Follow the "General Maintenance Guidelines" for proper management of instruments.
2. Rinse and/or presoak.
3. Clean manually using a mild soap and warm water with soft bristle brushes.
4. Clean the inside channel of the smoke evacuation tube using a round bristle brush with warm water once again.
5. Rinse.
6. An enzymatic cleaner should be used to remove protein deposits on the instrument. Follow enzymatic manufacturer's instructions.
7. Rinse.
8. Dry with clean cloth or gauze and compressed air.
9. Inspect.
10. Prepare for storage and/or sterilization.

NOTE: *Make sure to dry instruments completely with compressed air (including the inside of channels) and/or a dry oven (maximum temperature 280 degrees F)*

STERILIZATION WITH AN APPROVED LIQUID CHEMICAL STERILANT:

1. Instruments have to be cleaned extensively following the above steps before cold sterilization. Cold soak solutions with a 2% glutaraldehyde solution may be used for sterilizing the instruments. Instruments are to be fully submerged. For sterilization times, follow the manufacturer's instructions. Soak and rinse thoroughly in two separate sterile, deionized water baths.
2. Reassembly: Reassemble the yoke to the remainder of the speculum assembly using the thumbnut removed previously.
3. Storage: It is recommended that instruments be stored dry in a moisture free area. The instruments should be stored individually in their shipping cartons or in a protective tray with partitions. If stored in drawers, protect with cloth or gauze.

AUTOCLAVE STERILIZATION:

1. Contact of plastic to bare metal should be avoided.
2. Items should be precisely cleaned of all foreign matter before sterilization following the above steps.
3. Follow the manufacturer's instructions for operation and loading of steam autoclave. There must be direct steam exposure to all surfaces of the instruments being sterilized.
4. Autoclave temperatures should not exceed 280 degrees F (137 degrees C) pressures should not exceed 32 psi (2.2 atmospheres).
5. Instruments should be sterilized in their "Open" position.

6. Gravity Displacement Cycles
 - a. 20-30 minutes at 270-275 degrees F
 - b. 30 minutes at 250 degrees F
7. Pre-Vacuum Cycles
 - a. 3-4 minutes at 270-275 degrees F

ETHYLENE OXIDE STERILIZATION:

1. Items shall be completely cleared of all foreign matter prior to sterilization following the above steps.
2. Instruments should be sterilized in their "Open" positions.
3. Follow the manufacturer's instructions for operation and loading. Direct exposure to all surfaces of the instruments being sterilized in necessary.
4. Recommended Ethylene Oxide Cycle:
 - a. Temperature – 125-130 degrees F
 - b. 50 degree RH (pre-humidity – 60 minutes -0-10 minutes
 - c. Pre Vacuum – 24" Hg +/- 2" Hg
 - d. Gas Pressure – 6-8 psig (550-660 mg L)
 - e. Exposure Time – 4 hours -0-0.25 hours
 - f. Post Vacuum – 24" Hg 2x +/- 2" Hg
 - g. Aeration – 12 -0/+1 hours at 120 degrees F

WARNING:

ALWAYS CHECK INSTRUMENTS BEFORE AND AFTER STERILIZATION TO ENSURE THAT NON-CONDUCTIVE COATING IS UNIFORM: METAL SHOULD NOT BE VISIBLE UNDERNEATH THE COATING. CONTACT BETWEEN EXPOSED METAL AND CHARGED ELECTRODE MAY CAUSE BURN TO PATIENT AND/OR PHYSICIAN.

RECOMMENDED STEPS FOR CLEANING, STERILIZATION AND MAINTENANCE OF SURGICAL INSTRUMENTS

1. RINSING

Immediately after surgery, remove organic materials by rinsing instruments under warm (not hot) running water. Rinse should remove most blood fluids and tissue. Do not process dissimilar metals (stainless, copper, chrome plated, etc.) together.

2. DISINFECTING

To protect medical personnel from contamination during cleaning, immerse instruments completely in an EPA approved disinfectant for approximately 10 minutes. Then rinse again.

CAUTION: Never expose stainless steel instruments to bleach or other corrosive chemicals to disinfect. Exposure to bleach may result in instrument pitting and will void all manufacturer guarantees.

3. CLEANING

All blood, dried body fluids and tissue should be completely removed from the instruments prior to sterilization. Several methods are available.

A. Soak

An enzymatic cleaner bath or a solution of water and neutral pH(7) detergent are effective in removing organic material from instruments. Instruments should be fully submerged for at least 10 minutes. Rinse instruments under running tap water to remove solutions.

B. Ultrasonic Cleaning

Most instruments manufacturers recommend ultrasonic cleaning as the most effective way to clean surgical instruments, particularly those with hinges, locks and other moving parts.

All instruments must be fully submerged. Make sure that "sharps" (scissors, knives, osteotomes, etc.) blades do not touch other instruments. A lid can be used to avoid splashing.

Change solution frequently, at least as often as the manufacturer's recommendation.

Rinse instruments with water to remove the cleaning solution.

Lubricate all hinged instruments which have any "metal to metal" action, at the screw or box lock. A non-silicone, water soluble surgical lubricant is recommended. Do not use industrial oils or lubricants.

C. Automatic Washer Sterilizers

Follow manufacturer's recommendations but ensure instruments are lubricated after the last rinse cycle and before sterilization cycle.

Caution: Needle Holders and Forceps may crack if sterilized with the ratchet in the closed position.

D. Manual Cleaning

If ultrasonic cleaning is not available, observe the following steps:

Use stiff nylon cleaning brushes. Do not use steel wool or wire brushes except specially recommended stainless steel wire brushes for instrument serrated areas, bone files, burs or on stained areas of knurled handles.

Use only neutral pH (pH7) detergents. If not rinsed off properly, low pH (acidic-less 6 pH) detergents breakdown the stainless protective surface resulting in pitting and/or black staining. High pH detergents (alkaline-more than 8 pH) can cause brown stains (phosphate surface deposit) which can also interfere with the smooth operation of instruments. Most brown stains are not rust and are easily removed with stain remover.

Brush delicate instruments carefully, and if possible, separate them from general instruments.

Make sure instrument surfaces are visibly clean and free from stains and tissue. Also inspect each instruments for proper function and condition. Check to make sure that:

Scissor blades glide smoothly all the way (they must not be loose when in closed position). Test by cutting thin gauze or surgical glove material three quarters of length of blade. Scissors should cut all the way to the tips, and not hang up.

Forceps (pickups) have properly aligned tips. Teeth must meet properly- without cracking action.

Hemostats and Needle Holders should not allow light between the jaws when closed in the first ratchet position. (hemostats may show a small opening half way in from the closed tip), lock an unlock easily, and joints should not be too loose. Check needle holders for wear on jaw surfaces.

Suction tubes are clean inside.

Biopsy Punches – Punch a clean hole into tissue paper.

Retractors function properly.

Cutting Instruments and knives have sharp undamaged blades.

After scrubbing, rinse instruments thoroughly under running water. While rinsing, open and close scissors, hemostats, needle holders, and other hinged instruments to make sure the hinge areas are rinsed out, as well as the outside of the instruments.

4. AFTER CLEANING

If instruments are to be stored, let them air-dry and store them in a clean and dry environment.

5. AUTOCLAVING

The sterilizer manufacturer's written instructions for cycle parameters should be followed. In general, though, the most common temperatures and time parameters are:

- A. For gravity displacement cycles, 10 to 25 minute exposure time at 132 to 135 degrees C (270 to 275 degrees F), 15 to 30 minute exposure time at 121 to 123 degrees C (250 to 254 degrees F).
- B. For pre-vacuum cycles, 3 to 4 minutes at 132 to 135 degrees C (270-275 degrees F)
- C. For steam-flush pressure-pulse cycles, 3 to 4 minutes at 132 to 135 degrees C (270-275 degrees F), 20 minutes at 121-123 degrees F (250 to 254 degrees F).
- D. Lubricate all hinged instruments which have any "metal to metal" action, at the screw or box lock. A non-silicone, water soluble surgical lubricant is recommended. Do not use industrial oils or lubricants.
- E. Sterilize instruments either individually or in sets. Individual Instruments – Disposable paper or plastic pouches are ideal. Make sure to use a wide enough pouch for instruments with ratchet locks so the instruments can be sterilized in an open (unlocked) position. Instruments locked during autoclaving can experience cracked hinges (box locks) or other problems because of heat expansion. If you wrap instruments, make sure the towel does not contain detergent residue, which can stain your instrument. Instruments Sets – Unlock all instruments and sterilize them in an open position. Place heavy instruments on bottom of set (when two layers are required). Do not overload chamber because an air pocket may form that hinders steam penetration.

CAUTION: With most portable tabletop autoclaves, at the end of the autoclave cycle- before the drying cycle- unlock the door and open it no more than a crack, about ¼" (6.4mm). Then run the dry cycle for the period recommended by the autoclave manufacturer. If the autoclave door is fully opened before the drying cycle- cold room air will rush into the chamber causing condensation on the instruments that may result in water stains for cause wet packs. Make sure autoclave filters and chambers are cleaned as recommended by the manufacturer.

6. COLD STERILIZATION

Most cold sterilization solutions render instruments sterile only after a 10 hour immersion. This prolonged chemical action can be more detrimental than the usual 20 minute autoclave cycle. If the instruments need to be "disinfected" only, a cold sterilization soak is acceptable, as disinfection will take place in approximately 10 minutes. Check manufacturer' specifications. Also see our warning in using bleach (paragraph 2)

Keep in mind the difference between:

Sterile – an absolute term (no living organism survives)

Disinfected – basically clean. Some organisms may survive.

Always use proper sterilization/cleaning technique to render the instrument in the require condition for use.

CAUTION: For instruments with tungsten carbide inserts, we do not recommend use of cold sterilization solutions. Cold sterilization solutions will deteriorate the instrument's jaw.

A

Abdominal Retractors	66-71
Adson Dressing Forceps	52
Adson Forceps	52
Adson Nerve Hooks.....	22
Adson Tissue Forceps	52
Adson-Brown Forceps	52
Adson-DeBakey Forceps.....	52
Allis Tissue Forceps.....	39
Artery Forceps.....	40
Atraumatic Tenacula	24
Auvard Vaginal Specula.....	14

B

Babcock Forceps	39
Baby Mixer Hemostatic Forceps.....	55
Baby Tischler Biopsy Forceps...6	
Backhaus Towel Clamps.....	72
Balfour Retractors.....	66
Bandage Scissors.....	50
Barrett Placenta Forceps.....	27
Barrett Uterine Tenaculum Forceps.....	24
Baumgartner Needle Holders...65	
Bergmann Sponge Forceps....	56
Berlind Speculum	15
Bierer Ovum Forceps	26
Biopsy Forceps, Cervical.....	6-8
Bonney Tissue Forceps	56
Bozeman Needle Holders.....	63
Bozeman-Heaney Needle Holders	63
Braun Episiotomy Scissors.....	46
Braun Tenaculum Forceps.....	24
Breisky Retractors	16
Breisky-Navrati Retractor.....	16
Brown Needle Holder	64
Brown Tissue Forceps	56
Brown-Adson Tissue Forceps...52	
Bumm Uterine Curettes.....	23
Burke-Style Biopsy Forceps	6
Busch Umbilical Scissors	46
Buxton Uterine Clamp	40

C

Canal Finder, Cervical	18
Canal Finder, Uterine	18
Cannula for two Tenacula	38
Cannulae, Uterine.....	38
Cavity Finders, Uterine	18
Cervical Biopsy Forceps.....	6-8
Cervical Hooks	22
Circumcision Clamps.....	39
Circumcision Instruments	39
Clamps, Circumcision.....	39
Clamps, Towel.....	72
Clamps, Uterine.....	40

Clark Artery Forceps	30,40
Collin Vaginal Specula	12
Collin Specula LLETZ/LEEP	43
Conductive Electrode Pads	42
Converse Needle Holders.....	64
Corey Placenta Forceps	26
Corson Myoma Grasping Forceps	40
Crafoord Scissors	46
Crile Hemostatic Forceps	53
Crile-Wood Needle Holders....	59
Curettes, Endocervical	9
Curettes, Endometrial.....	9
Curettes, Placenta	23
Curettes, Uterine	23
Cusco Vaginal Specula.....	12
Cushing Vein Retractor	71

D

De Lee Retractors	17
Deaver Retractor	68
Deaver Scissors.....	47
DeBakey Needle Holders	60
DeBakey Tissue Forceps.....	51
DeBakey-Adson Forceps.....	52
Denniston Dilators	20
Derf Needle Holders	59
Dermal Punch Set	72
Deschamp Ligature Carries....	38
Desjardin Forceps	27
Dilators, Uterine.....	18-20
Disposable Flexible Dilator	5
Disposable Uterine Sound.....	5
Dissecting Scissors	48,49
Double I.U.D. Extractor	21
Doyen Retractors.....	70
Dressing Forceps	51,52,57
Dressing Forceps, Non-Conductive	44
Dressing Forceps, Uterine.....	51
Duncan Curettes.....	9
Duplay Uterine Tenaculum Forceps.....	25

E

Eastman Vaginal Retractors ...	17
Edna Towel Clamps	74
Electrode Pads	42
Electrodes, Loop.....	41
Electrosurgical Instruments.....	41-44
Emmett Hooks, LLETZ/LEEP...43	
Emmett Tenaculum Hooks.....	22
Endocervical Curettes	9
Endocervical Specula.....	10
Endocervical Specula LLETZ/LEEP	43,44
Endometrial Curettes.....	9

Endometrial Sampler	5
Eppendorfer Biopsy Forceps	7
Extra Large Vaginal Specula ...	11
Extra Long Allis Forceps.....	39
Extra Long Babcock Forceps ..	39
Extra Long Cushing Vein Retractors	71
Extra Long Dressing Forceps...51	
Extra Long Hemostatic Forceps.....	54,55
Extra Long Hysterectomy Forceps.....	29
Extra Long Hysterectomy ZED-Scissors.....	45
Extra Long Metzenbaum Scissors	49
Extra Long Needle Holders	62,65
Extra Long Potts Smith Forceps.....	57
Extra Long Russian Forceps...58	
Extra Long Singley Forceps....	58
Extra Long Sponge Forceps...56	
Extra Long Tissue Forceps.....	51
Extra Long Yankauer Suction Tubes	40
Extractor, I.U.D	21
eZinject Catheter	3

F

Farabeuf Retractors.....	71
Ferris-Smith Tissue Forceps...58	
Finochietto Scissors	46
Flexible Cervical Dilator Set ...	18
Foerster Sponge Forceps.....	56
Forbes Placenta/Ovum Forceps.....	26
Forceps, Polyp	28, 45
Forceps, Biopsy	6-8
Forceps, Cervical Biopsy.....	6-8
Forceps, Cervix Holding	45
Forceps, Dressing....	52,53,57,58
Forceps, Hemostatic.....	54-56
Forceps, Hysterectomy.....	29-31
Forceps, Mosquito	53
Forceps, Myoma Grasping	40
Forceps, Ovum	26-28
Forceps, Placenta.....	26,27
Forceps, Sponge Holding	75
Forceps, Tenaculum.....	24,25
Forceps, Tissue ..	52,53,56,57,58
Forceps, Uterine Tenaculum...24	
Forceps, Uterine Vulsellum	24-28
Frank Speculum.....	14

G

Garrigue Specula	15
Gelpi Retractors.....	66

Gerald Dressing Forceps.....	57
Gerald Tissue Forceps	57
Glenner Hysterectomy Forceps.....	31
Goelet Retractors	69
GOMCO Circumcision Clamps...34	
Graves Vaginal Specula.....	11
Graves Vaginal Specula, LLETZ/LEEP	43
Guttman Vaginal Speculum	12
GYN Hooks.....	22
GYN Scissors	46

H

Halsey Needle Holders.....	65
Halsted Mosquito Forceps.....	53
Hand Switching Pencils	42
Handles, Electrode	42
Hank Uterine Dilators	20
Hartman Mosquito Forceps	53
Heaney Hysterectomy Forceps.....	30
Heaney Needle Holders	62
Heaney Tissue Forceps	56
Heaney Uterine Curette.....	9
Heaney Vaginal Retractors	17
Heaney-Ballantine Hysterectomy Forceps...30	
Heaney-Rezek Hysterectomy Forceps...31	
Hegar Uterine Dilators	20
Hemostatic Forceps.....	53-55
Henrotin Speculum	15
Hoesel Needle Holders.....	65
Hooks, Cervical	22
Hooks, I.U.D. Extractor	21
Hooks, LLETZ.....	43
HS Catheter.....	2
HS Procedure Tray.....	2
Hulka Uterine Mobilizer	40
Hysterectomy Forceps.....	29-31
Hysterectomy Forceps, Zed ZClamps	29
Hysterectomy Scissors, Z-Clamp.....	45

I

I.U.D. Extractor Hook	21
Injector, Uterine	4,38
Iowa Vulsellum Forceps	25
Iris Hooks	22
Iris Hooks, LLETZ/LEEP.....	43
Iris Scissors	50

J

Jackson Vaginal Speculum	17
Jacobs Uterine Vulsellum Forceps	28

Jarcho Cannula	38
Javerts Placenta Forceps	27
Jorgenson Scissors	46
Joseph Scissors	45

K

Kahn Uterine Cannula	38
Kelly Hemostatic Forceps	54
Kelly Placenta Forceps	27
Kelly Retractors	70
Kelly Scissors	45
Kelly Vulsellum Forceps.....	28
Kevorkian Biopsy Forceps	7
Kevorkian Endocervical Curettes	9
Keyes Dermal Punches	72
Kilner Needle Holder	64
Kirschner Retractor.....	66
Kleegman Dilator	19
Kocher Hemostatic Forceps ...	54
Kogan Endocervical Specula...10	
Kogan Endocervical Specula, LLETZ/LEEP.....	43

L

Lane Forceps.....	58
Lateral Vaginal Retractors	13
Ligature Carrier Miya Hook.....	38
Lister Bandage Scissors.....	50
LLETZ/LEEP Accessories...41,42	
LLETZ/LEEP Electrode Pads...42	
LLETZ/LEEP Instruments...43,44	
LLETZ/LEEP LoopElectrodes.....	41
LLETZ/LEEP Systems.....	41-44
Loop Electrodes.....	41
Lorna Towel Clamps	72
Lugol's Solution	42

M

M.D. Anderson Clamps.....	30
Manipulator, Uterine	1
Masson Needle Holders	60
Masterson Hysterectomy Forceps.....	30
Mathieu Needle Holders	63
Mathieu-Olsen-Hegar Needle Holders.....	63
Mayo Retractors	71
Mayo Russian Tissue Forceps	58
Mayo Scissors	47,48
Mayo-Adams Retractors	67
Mayo-Harrington Scissors	48
Mayo-Hegar Needle Holders...60	
Mayo-Noble Dissecting Scissors	48
Mayo-Stille Scissors	48

Measuring Rulers, LLETZ/LEEP	43
Metzenbaum Scissors	49
Mini Dilators.....	19
Miya Hook.....	38
Miya Notched Speculum.....	11
Mobilizers, Uterine	1
Mogen Circumcision Clamps...39	
Monsel's Solution.....	42
Mosquito Forceps	54
Myoma Grasping Forceps, Corson	40

N

Needle Extenders	22
Needle Holders.....	59-65
Neivert Needle Holder	64
Nerve Hooks.....	22
New Orleans Needle Holders...60	
Nolan Needle Holder	65
Non-Conductive Instruments.....	41-44
Novak Endometrial Curettes.....	9

O

O'Brien Stitch Scissors.....	50
O'Sullivan-O'Connor Abdominal Retractors	67
O'Connor -O'Sullivan Vaginal Retractors	13
Ochsner-Kocher Hemostatic Forceps.....	55
Olsen-Hegar Needle Holders	63,65
Operating Scissors	47,48
Os Finder Set	18
Os Finder, Cervical.....	5,18
Ovum Forceps	26-28

P

Parker Retractors.....	71
Pederson Vaginal Specula.....	11
Pederson Vaginal Specula, LLETZ/LEEP	43
Pennington Forceps.....	55
Pessaries.....	32-37
Phaneuf Uterine Artery Forceps	31
Placenta Curettes	23
Placenta Forceps.....	26,27
PLUS SIZE Allis Forceps.....	39
PLUS SIZE Babcock Forceps...39	
PLUS SIZE Cushing Vein Retractors	71
PLUS SIZE Dressing Forceps ..51	
PLUS SIZE Hemostatic Forceps.....	54,55

PLUS SIZE Hysterectomy Forceps.....	29
PLUS SIZE Hysterectomy ZED-Scissors.....	45
PLUS SIZE Metzenbaum Scissors ...	49
PLUS SIZE Needle Holders	62,65
PLUS SIZE Potts Smith Forceps.....	57
PLUS SIZE Russian Forceps...	58
PLUS SIZE Singley Forceps...	58
PLUS SIZE Sponge Forceps...	56
PLUS SIZE Tissue Forceps...	51
PLUS SIZE Vaginal Specula...	11
PLUS SIZE Yankauer Suction Tubes	40
Polyp Forceps.....	28,45
Potts-Smith Dressing Forceps.....	57
Potts-Smith Tissue Forceps...	55
Pratt Uterine Dilators	19,20
Providence Hospital Forceps...	55
Punches, Dermal.....	72

R

R.W.R. Retractor.....	13
Radiance Instruments	6,9,11,23,45
Randall Endometrial Curette	9
Randall Forceps	28
Redundant Wall Retractor (RWR).....	13
Redundant Wall Retractor (RWR),LLETZ/LEEP	43
Retractors, General Operating	66,68
Retractors, Vaginal	12,13
Ribbon Retractors.....	68
Richardson Retractors.....	70
Richardson-Eastman Retractors	69
Rochester Pean Forceps	54
Rogers Hysterectomy Forceps.....	31
Roto-Fit Biopsy Forceps	8
Russian Tissue Forceps	58

S

Sarot Needle Holders	62
Satinsky Scissors	45
Scalpel Handles.....	72
Schmidt Tonsil Forceps.....	658
Schroeder Tenaculum Forceps.....	24
Schroeder Tenaculum, LLETZ/LEEP	43
Schroeder Uterine Vulsellum Forceps.....	25

Schubert Biopsy Forceps	8
Scissors, Bandage.....	50
Scissors, Iris	50
Scissors, Operating	47,48
Scissors, Strabismus	50
Semken Tissue Forceps	58
Scissors, Uterine	46,47
Selman (Mini Russian) Forceps.....	57
Siebold Uterine Scissors	47
Siegler-Helman Clamp	40
Simple I.U.D. Hook.....	21
Simpson Uterine Sound	21
Sims Scissors	45
Sims Uterine Curettes	23
Sims Uterine Sound	21
Sims Vaginal Retractors	16
Singley Tissue Forceps.....	58
Small Scissors	50
Smoke Evacuator Accessories	42
Sono-Inject	3
Sopher Ovum Forceps	26
Sounds, Uterine.....	21,5
Specula, Endocervical.....	10
Specula, Endocervical, LLETZ/LEEP	43
Specula, LLETZ/LEEP.....	43
Specula, Miya Hook.....	11
Specula, Vaginal.....	11-16
Spencer Stitch Scissors.....	50
Sponge Forceps, Non-Conductive	44
Sponge Holding Forceps	56
Staude-Moore Tenaculum Forceps.....	25
Steiner Speculum	14
Stitch Scissors	50
Strabismus Scissors	50
Stratte Needle Holders	62
Stylet for HS Catheter.....	2

T

Taylor Dressing Forceps	57
Taylor Tissue Forceps.....	57
Teale Vulsellum Forceps.....	25
Tenacula, LLETZ/LEEP	43
Tenaculum Forceps, Uterine	24,25
Tenaculum Hooks	22
Thorek Scissors.....	46
Tischler Biopsy Forceps	6
Tissue Forceps, Non-Conductive	44

U

U.S. Army Retractors	69
U.S.A. Umbilical Scissors	46
Umbilical Scissors	46

Universal IUD Hook	21
Uterine Cannula.....	4,38
Uterine Curettes	23
Uterine Dilators.....	18-20
Uterine Injectors	4,38
Uterine Manipulator	1
Uterine Mobilizers.....	1,45
Uterine Scissors	45
Uterine Sounds.....	21,5

V

Vaginal Retractors	16,17
Vaginal Rulers, Non-Conductive	43
Vaginal Specula.....	11-16
Vaginal Specula, LLETZ/LEEP	43
Vulsellum Forceps, Uterine	25-28

W

Webster Needle Holders	59
Weighted Specula	14,15
Weighted Specula, LLETZ/LEEP	44
Weisman-Graves Vaginal Speculum.....	11
Weisman-Graves Vaginal Speculum LLETZ/LEEP...	44
Willauer Scissors	47
Wittner Biopsy Forceps	7

Y

Yankauer Suction Tubes	40
------------------------------	----

Z

ZED-Clamp Scissors	45
ZED-Clamps	29
ZED-More Specula, LLETZ/LEEP	44
Z-Sampler.....	5
Zeppelin Instruments (Z-Clamps and Scissors).....	29,46

B&H SURGICAL

Our Policies

Shipping and Handling

B & H Surgical will attempt to ship all orders promptly and keep you notified of the status of your order.

We offer the following shipping methods:

FedEx Express
FedEx Ground
UPS 3-Day Select
UPS Ground

Returns

Customers on occasion ask us about our return policy. At B & H Surgical we aim for complete customer satisfaction. If you are not completely pleased with your order, we want to hear about it. Let us know if something is wrong and we will do what we can to make it right. If you need to return an item and it qualifies for returning call for an RMA number within 30 days of purchase.



B&H SURGICAL

Specializing in OB/GYN and GI Products



B&H SURGICAL

P.O. Box 800192 • Santa Clarita, CA 91380-0192

Toll-Free: (800) 971-9066 or (661) 257-0788 • Fax: (661) 257-0688

www.bhsurgical.com • E-mail: sales@bhsurgical.com